

# 316F L

Hydraulic Excavator



## Engine

Engine Model	Cat® C4.4 ACERT™
Net Power – SAE J1349/ISO 9249	88 kW (120 PS)
Gross Power – SAE J1995	91 kW (124 PS)
Engine Power – ISO 14396	91 kW (124 PS)

## Drive

Maximum Travel Speed	5.3 km/h
Maximum Drawbar Pull	156 kN

## Weight

Minimum Operating Weight	17 200 kg
Maximum Operating Weight	18 500 kg



## Introduction

*The new Cat 316FL is a perfect choice for customers who value reliable, economical performance. Powered by a fuel-efficient U.S. EPA Tier 4 Final and EU Stage IV emission standards C4.4 ACERT engine, the machine features a state-of-the-art hydraulic system that enables you to move material all day long with tremendous speed and precision.*

*When you add in a quiet operator environment that keeps you comfortable and productive, robust structures that keep you grounded and balanced, easy-to-reach service points that make your routine maintenance fast and simple, and multiple Cat work tools that help you take on a variety of tasks, you just won't find a better, more efficient excavator in its size class – any place, anywhere.*

## Contents

Hydraulics .....	4
Engine .....	5
Operator Station.....	6
Structures & Undercarriage .....	7
Integrated Technologies.....	8
Front Linkage .....	10
Attachments.....	11
Serviceability .....	12
Safety .....	13
Complete Customer Care.....	14
Sustainability .....	15
Specifications.....	16
Standard Equipment.....	34
Optional Equipment.....	35









# Hydraulics

Power to move your material with speed and precision



## A Powerful, Efficient Design

When it comes to moving material quickly and efficiently, you need hydraulic horsepower – the type of ground-breaking power the 316F L can deliver. Major hydraulic components like pumps and valves are located close together so shorter tubes and lines can be used. This design leads to less friction loss, reduced pressure drops, and more power to the ground for the work you need to get done.

## Control Like No Other

Controllability is one of the main attributes of Cat excavators, and one of the key contributors to this is the main control valve. The valve opens slowly when your range of joystick lever movement is small and opens rapidly when movement is high. It puts flow where you need it when you need it, which leads to smoother operation, greater efficiency, and lower fuel consumption.

## Auxiliary Hydraulics For Added Versatility

Auxiliary hydraulics give you greater tool versatility so you can take on more work with just one machine, and there are several options from which you can choose. A quick coupler circuit, for example, will allow you to switch from one tool to another in a matter of minutes – all from the comfort and convenience of the cab.

## Boom & Stick Oil Recirculation For Added Efficiency

The 316F L recirculates the flow of oil from the head end of the boom and stick cylinders to the rod end of the boom and stick cylinders during the work cycle to save energy and improve fuel efficiency. It's optimized for any dial speed setting you select, which results in less pressure loss for higher controllability, more productivity, and lower operating costs for you.

# Engine

Powerful and fuel efficient to meet your expectations

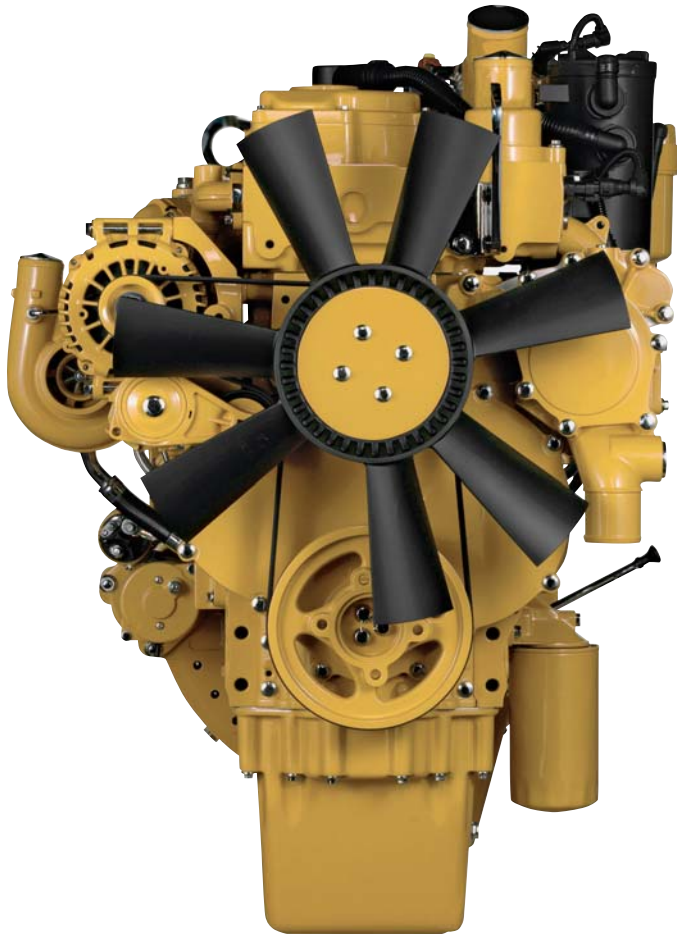

## Proven Technology

The Cat C4.4 ACERT engine meets Tier 4 Final and Stage IV emission standards, and it does so without interrupting your job process. Simply turn the engine on and go to work. It will look for opportunities in your work cycle to regenerate itself, and it will give you plenty of power for the task at hand – all to help keep your owning and operating costs to an absolute minimum.

Like every Cat Tier 4 Final and Stage IV emission compliance engine, the C4.4 ACERT engine is equipped with a combination of proven electronic, fuel, air, and aftertreatment components. Applying these time-tested technologies lets us meet your high expectations for productivity, fuel efficiency, reliability, and service life.

Following are the results you can expect:

- **Improved fluid efficiency of up to 5%** over Tier 4 Interim/ Stage IIIB products, including Diesel Exhaust Fluid (DEF) consumption.
- **High performance** across a variety of applications.
- **Enhanced reliability** through commonality and simplicity of design.
- **Maximized uptime and reduced cost** with world-class Cat dealer support.
- **Minimized impact** on emission systems – with no operator interaction required.
- **Durability** with long service life.
- **Better fuel economy** with minimized maintenance costs.
- **Same great power** and response.

# Operator Station

Comfort and convenience to keep you productive

## Comfortable Seat Options

The seat range includes air suspension, heated, and air cooled options. All seats include a reclining back, upper and lower slide adjustments, and height and tilt angle adjustments to meet your needs for maximum comfort.

## A Safe, Quiet Cab

The ROPS cab provides you with a safe working environment when properly seated and belted. It also contributes to your comfort because it's attached to a reinforced frame with special viscous mounts that limit vibration and unnecessary sound. Add in special roof lining and sealing and you have a cab that's as quiet inside as today's top pickup trucks.

## A Cool & Warm Environment

The automatic climate control system features multiple air outlets with filtered ventilation. Air flows on the floor, behind the seat, and in front of you to make your work in either hot or cold weather much more pleasant and productive.

## Controls Just For You

The right and left joystick consoles can be adjusted to improve your comfort and productivity during the course of a day. Also, the right joystick features a button that will reduce engine speed when you are not working to help save fuel. Touch it once and speed reduces; touch it again and speed increases for normal operation.



## A Helpful Monitor

The LCD monitor is easy to see and navigate. Programmable in up to 42 languages to meet today's diverse workforce, the monitor clearly displays critical information you need to operate efficiently and effectively. Plus it projects the image from the standard rearview camera to help you see what's going on around you so you can stay safely focused on the job at hand.

## Ample Storage & Auxiliary Power

Storage spaces are located in the front, rear, and side consoles of the cab. A drink holder accommodates a large mug, and a shelf behind the seat stores large lunch or toolboxes. Two 12-volt power supply sockets are conveniently located near the key storage areas for charging your electronic devices like an MP3 player, a cell phone, or a tablet.





# Structures & Undercarriage

Designed to work in your rugged applications

## Robust Frame

The 316F L is a well-built machine designed to give you a very long service life. The upper frame has mountings made specifically to support the heavy-duty cab; it is also reinforced around key areas that take on stress like the boom foot and skirt. Massive bolts are used to attach the track frames to the body, and additional bolts are used to increase the machine's digging force, which leads to more productivity for you.

## Durable Undercarriage

The 316F long undercarriage contributes significantly to its outstanding stability and durability. Track shoes, links, rollers, idlers, and final drives are all built with long-lasting, high-tensile-strength steel. Cat Grease Lubricated Track 2 (GLT2) track link protects moving parts by keeping water, debris, and dust out and grease sealed in, which delivers longer wear life and reduced noise when traveling. Optional guide guards help maintain track alignment to improve the machine's overall performance – whether you're traveling on a flat, heavy bed of rock or a steep, wet field of mud.



# Integrated Technologies

Monitor, manage, and enhance job site operations



Cat Connect makes smart use of technology and services to improve your job site efficiency. Using the data from technology-equipped machines, you'll get more information and insight into your equipment and operations than ever before.

Cat Connect technologies offer improvements in these key areas:



EQUIPMENT  
MANAGEMENT

**Equipment Management** – increase uptime and reduce operating costs.



PRODUCTIVITY

**Productivity** – monitor production and manage job site efficiency.



SAFETY

**Safety** – enhance job site awareness to keep your people and equipment safe.

## LINK Technologies

LINK technologies, like Product Link™, are deeply integrated into your machine and wirelessly communicates key information, including location, hours, fuel usage, idle time and event codes.

## Product Link/VisionLink®

Easy access to Product Link data via the online VisionLink user interface can help you see how your machine or fleet is performing. You can use this information to make timely, fact based decisions that can boost job site efficiency and productivity, and lower costs.





## GRADE Technologies

Grade technologies combine digital design data and in-cab guidance to help you reach target grade quickly and accurately, with minimal staking and checking. That means you'll be more productive, complete jobs faster, in fewer passes, using less fuel, at a lower cost.



### Cat Grade Control Depth and Slope

The factory integrated Cat Grade Control system delivers 2D bucket tip elevation guidance to the cab to help operators create precise planes and slopes with ease. Real-time bucket tip elevation guidance on the easy-to-read standard cab monitor indicates how much to cut or fill. Fast response sensors deliver immediate feedback, while optional integrated joystick buttons help operators make quick adjustments to maintain consistent, quality grades. Built-in alerts can be set to warn the operator if the linkage or bucket approaches a predefined elevation or depth, such as when working in areas with low ceilings, or digging near water lines. Staking and checking is minimized, which reduces ground crews and enhances job site safety.

Works best in simple 2D applications, such as digging basements or grading steep embankments. Easily upgrade to AccuGrade™ when 3D guidance is required.

### Cat AccuGrade

The dealer-installed AccuGrade system provides 3D guidance for making complex cuts and contours, eliminating the need for staking and checking. A dedicated monitor displays a digital design plan with 3D bucket tip positioning and elevation guidance, indicating precisely where to work and how much to cut or fill.

Plug and play capability on the 336F simplifies upgrading. Choose from satellite (GNSS) control for large projects with complex designs or total station (UTS) systems in areas with limited reception.



# Front Linkage

Options to take on your far-reaching and up-close tasks



## Designed For Range

The 316F L is offered with a reach boom and four stick configurations: R3.1 m, R2.9 m, R2.6 m and R2.25 m. Reach configurations balance digging force and bucket capacity, covering all applications this size of machine was designed to take on such as trenching, loading, and doing demolition work with hydraulic tools.

In Europe, we also offered Variable Angle boom configuration with two stick options: R2.6 m and R2.25 m. Variable Angle Boom offers superb flexibility and versatility in the working envelope. Boom position can be adjusted from 90° when fully retracted to 180° and fully extended. With full extension, the working range gives maximum dig depth, reach, and working height. Equally, when retracted, it can work closer to its tracks, increase lifting capacity, and work in confined areas.

## Made To Last

Each boom and stick is built with internal baffle plates for maximum durability, and each undergoes ultrasound inspection to ensure quality and reliability for the tough work you do.

Talk to your Cat dealer to pick the best front linkage for your specific applications.



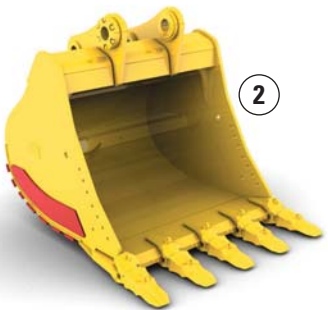
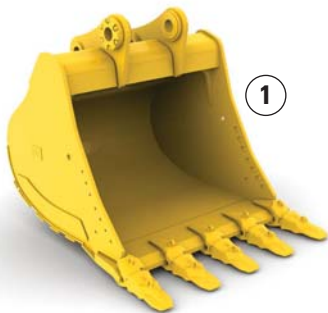

1) General Duty (GD) 2) Heavy Duty (HD)

# Attachments

Tools to make you productive and profitable

### Change Jobs Quickly

Cat quick coupler brings the ability to quickly change attachments and switch from job to job.

### Dig, Finish, or Break

A range of buckets dig everything from top soil to abrasive material. For finishing and grading work, compact and shallow ditch cleaning buckets fit the need.

A hydraulic hammer equips the machine for breaking sidewalks, driveways, and pavement.

### Set Up Your Machine For Profitability

Your Cat dealer can install hydraulic kits to properly operate all Cat Work Tool attachments – maximizing the machine’s uptime and your profits. All Cat Work Tool attachments are supported by the same Cat dealer network as your Cat machine.



# Serviceability

Designed to make your maintenance quick and easy

## Safe, Convenient Access

You can reach most routine maintenance items like fluid taps and grease points from the safety and convenience of ground level. You will also find filters banked together for higher service efficiency. Compartments feature wide service doors designed to help prevent debris entry, and they also securely latch in place to help make your service work simpler.

## A Smart Design

The high-ambient cooling system features a fuel-saving variable-speed fan and a side-by-side-mounted radiator and oil and air coolers for easy cleaning. Wider clearance between the two makes blowing off debris easy for you, which can help improve your machine's reliability and performance.

## A Fresh Idea

When you select ventilation inside the cab, outside air enters through the fresh air filter. The filter is conveniently located on the side of the cab to make it easy to reach and replace, and it is protected by a lockable door that can be opened with the engine key.

## More Service Benefits

Filters are banked together to enhance service efficiency. The fuel tank's drain tube makes it easy and simple for you to remove water and sediment during routine maintenance. Plus an integrated fuel level indicator pops up to help you reduce the possibility of fuel tank overfilling.





# Safety

Features to help protect you day in and day out



## A Safe, Quiet Cab

The ROPS cab provides you with a safe working environment when properly seated and belted. It also contributes to your comfort because it's attached to a reinforced frame with special viscous mounts that limit vibration and unnecessary sound. Add in special roof lining and sealing and you have a cab that's as quiet inside as any of today's top pickup trucks.

## Secure Contact Points

Multiple large steps get you into the cab as well as a leg up to the compartments. Extended hand and guard rails allow you to safely climb to the upper deck. Anti-skid plates reduce your slipping hazards in all types of weather conditions, and they can be removed for cleaning.

## Great Views

Ample glass gives you excellent visibility out front and to the side, and the standard rearview camera gives you a clear field of view behind the machine through the cab monitor. The available split-configuration windshield features an upper window with handles that make it easy to slide and store above you and a lower window that can be removed and stored on the inside wall of the cab. The large skylight also serves as an emergency exit and provides you with enhanced overhead visibility.

## Smart Lighting

Halogen lights provide plenty of illumination, and the cab and boom lights can be programmed to stay on for up to 90 seconds after the engine has been turned off to help you safely exit the machine.





## Complete Customer Care

Service you can count on

### **Parts Where You Work**

Cat dealers utilize a worldwide parts network to maximize your machines' uptime. Plus they can help you save money with Cat remanufactured components.

### **Advice You Can Trust**

What are the job requirements and machine attachments? What production is needed? Your Cat dealer can provide recommendations to help you make the right machine choices.

### **Financial Options Just For You**

Consider financing options and day-to-day operating costs. Look at dealer services that can be included in the machine's cost to yield lower owning and operating costs over time.

### **Support Agreements To Fit Your Needs**

Cat dealers offer a variety of customer support agreements and work with you to develop a plan to meet your specific needs. These plans can cover the entire machine, including attachments, to help protect your investment.

### **Operating Techniques To Boost Your Profits**

Improving operating techniques can boost your profits. Your Cat dealer has videos, literature, and other ideas to help you increase productivity. Caterpillar also offers simulators and certified operator training to help maximize the return on your investment.



# Sustainability

## Generations ahead in every way



- The C4.4 ACERT engine meets Tier 4 Final and Stage IV emission standards.
- The engine can run on either ultra-low-sulfur diesel (ULSD) fuel with 15 ppm (10 ppm level in EU standards) of sulfur or less or biodiesel (up to B20) fuel blended with ULSD that meets ASTM 6751 standards.
- An overfill indicator rises when the fuel tank is full to help service technicians avoid spilling.
- The QuickEvac™ option ensures fast, easy, and secure changing of engine and hydraulic oil.
- The machine is built to be rebuilt with major structures and components capable of being remanufactured to reduce waste and replacement costs.
- An efficient engine oil filter eliminates the need for painted metal cans and aluminum top plates. The cartridge-style spin-on housing enables the internal filter to be separated and replaced; the used internal element can be incinerated to help reduce waste.
- The 316F L is an efficient, productive machine that's designed to conserve our natural resources for generations ahead.

# 316F L Hydraulic Excavator Specifications

## Engine

Engine Model	Cat C4.4 ACERT
Gross Power – SAE J1995	91 kW (124 PS)
Engine Power – ISO 14396	91 kW (124 PS)
Net Power – SAE J1349/ISO 9249	88 kW (120 PS)
Bore	105 mm
Stroke	127 mm
Displacement	4.4 L

## Weights

Minimum Operating Weight*	17 200 kg
Maximum Operating Weight**	18 500 kg

\*5.1 m boom, 2.25 m stick, 2.8 mt counterweight, 0.76 m<sup>3</sup> GD bucket, and 500 mm.

\*\*Variable Angle Boom, R2.6 stick, 2.8 mt counterweight, 0.76 m<sup>3</sup> GD bucket, 700 mm shoes.

## Hydraulic System

Main System – Maximum Flow (Total)	300 L/min
Maximum Pressure – Equipment	35 000 kPa
Maximum Pressure – Travel	35 000 kPa
Maximum Pressure – Swing	25 000 kPa
Pilot System – Maximum Flow	25 L/min
Pilot System – Maximum Pressure	4120 kPa
Boom Cylinder – Bore	110 mm
Boom Cylinder – Stroke	1193 mm
Stick Cylinder – Bore	120 mm
Stick Cylinder – Stroke	1331 mm
Bucket Cylinder – Bore	110 mm
Bucket Cylinder – Stroke	1039 mm

## Drive

Gradeability	30°/70%
Maximum Travel Speed	5.3 km/h
Maximum Drawbar Pull	156 kN

## Swing Mechanism

Swing Speed	8.9 rpm
Swing Torque	49.6 kN·m

## Service Refill Capacities

Fuel Tank Capacity	290 L
Cooling System	26 L
Engine Oil (with filter)	13.5 L
Swing Drive	8 L
Final Drive (each)	8 L
Hydraulic System (including tank)	121 L
Hydraulic Tank	106 L
DEF Tank Capacity	20.5 L

## Track

Number of Shoes (each side)	44 pieces
Number of Track Rollers (each side)	7 pieces
Number of Carrier Rollers (each side)	2 pieces

## Sound Performance

Operator Sound Pressure Level (ISO 6396:2008)	71 dB(A)
Exterior Sound Power Level (ISO 6395:2008)*	102 dB(A)

\* European Union Directive “2000/14/EC” as amended by “2005/88/EC.”

- Hearing protection may be needed when operating with an open operator station and cab (when not properly maintained or doors/windows open) for extended periods or in noisy environment.

## Standards

Brakes	ISO 10265 2008
ROPS cab	ISO 12117-2 2008
Cab/OPG	ISO 10262 1998



# 316F L Hydraulic Excavator Specifications

## Dimensions

All dimensions are approximate.

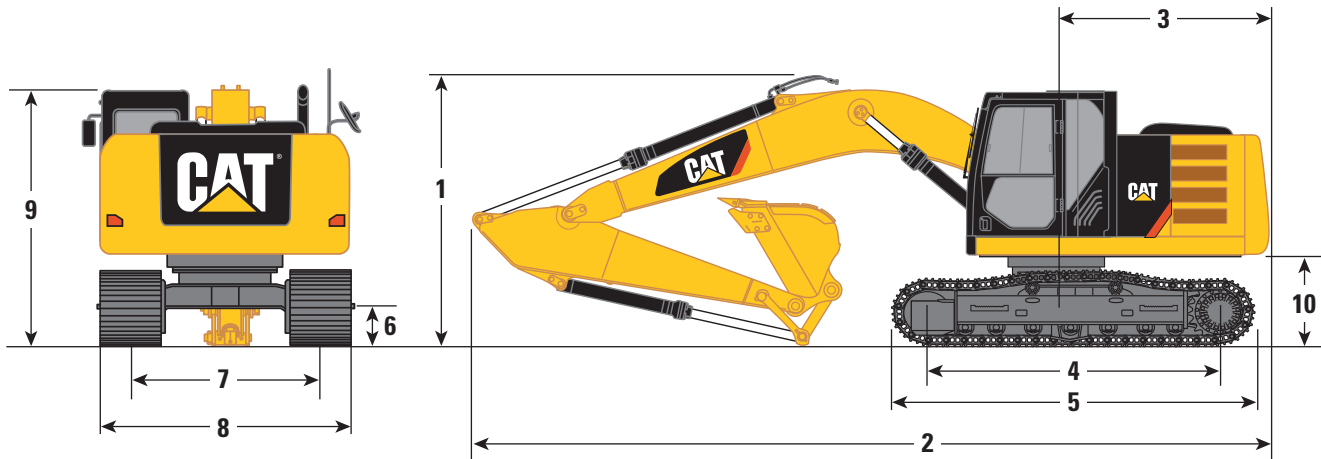

Boom Options	Reach Boom 5.1 m				Variable Angle Boom	
	R3.1	R2.9	R2.6	R2.25	R2.6	R2.25
Stick Options	GD	GD	GD	GD	GD	GD
Bucket Type	GD	GD	GD	GD	GD	GD
Bucket Capacity	0.76 m <sup>3</sup>	0.76 m <sup>3</sup>	0.76 m <sup>3</sup>	0.76 m <sup>3</sup>	0.76 m <sup>3</sup>	0.76 m <sup>3</sup>
Tip Radius	1380 mm	1380 mm	1380 mm	1380 mm	1380 mm	1380 mm
1 Shipping Height	3190 mm	3100 mm	3050 mm	3020 mm	2980 mm	2930 mm
2 Shipping Length	8570 mm	8580 mm	8570 mm	8570 mm	8630 mm	8640 mm
3 Tail Swing Radius	2500 mm	2500 mm	2500 mm	2500 mm	2500 mm	2500 mm
4 Length to Center of Rollers	3170 mm	3170 mm	3170 mm	3170 mm	3170 mm	3170 mm
5 Track Length	3970 mm	3970 mm	3970 mm	3970 mm	3970 mm	3970 mm
6 Ground Clearance	440 mm	440 mm	440 mm	440 mm	440 mm	440 mm
7 Track Gauge	1990 mm	1990 mm	1990 mm	1990 mm	1990 mm	1990 mm
8 Transport Width						
500 mm Shoe	2520 mm	2520 mm	2520 mm	2520 mm	2520 mm	2520 mm
600 mm Shoes	2590 mm	2590 mm	2590 mm	2590 mm	2590 mm	2590 mm
700 mm Shoes	2690 mm	2690 mm	2690 mm	2690 mm	2690 mm	2690 mm
9 Cab Height	2890 mm	2890 mm	2890 mm	2890 mm	2890 mm	2890 mm
Cab Height with Top Guard	3100 mm	3100 mm	3100 mm	3100 mm	3100 mm	3100 mm
10 Counterweight Clearance	1010 mm	1010 mm	1010 mm	1010 mm	1010 mm	1010 mm

# 316F L Hydraulic Excavator Specifications

## Working Ranges

All dimensions are approximate.

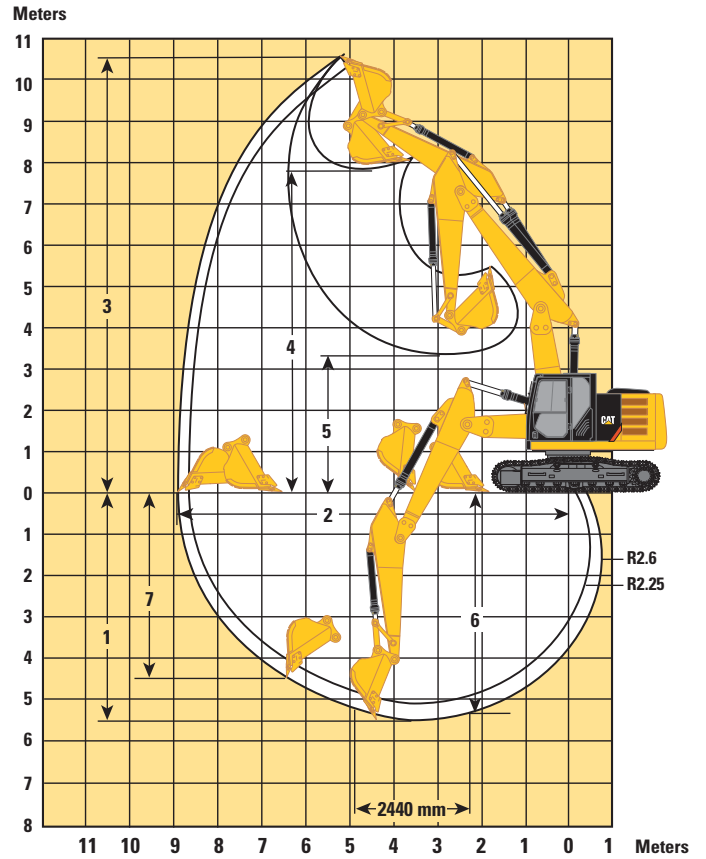
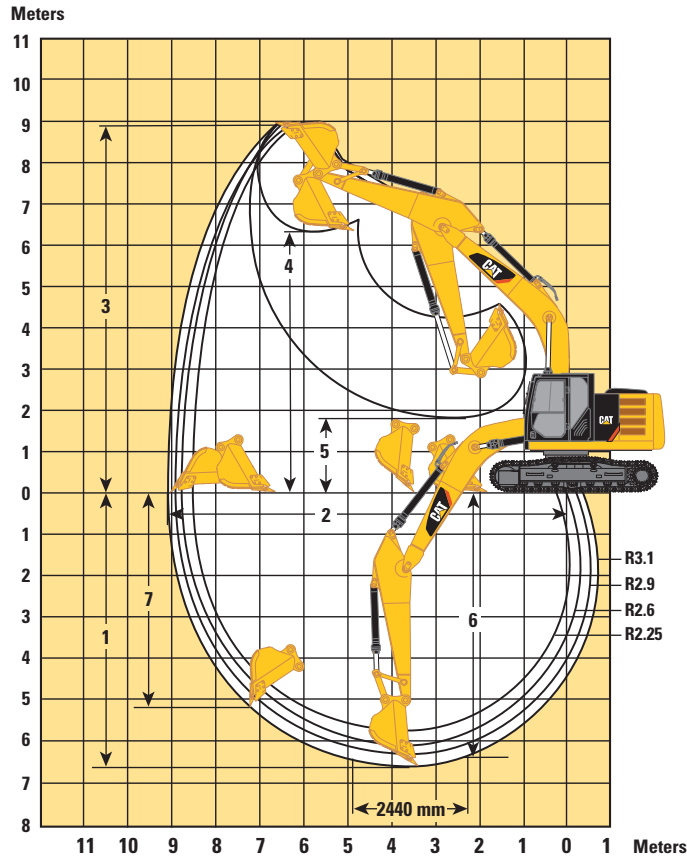

	Reach Boom 5.1 m				Variable Angle Boom 5.1 m	
	R3.1	R2.9	R2.6	R2.25	R2.6	R2.25
<b>Stick</b>						
<b>Bucket</b>	0.76 m <sup>3</sup>	0.76 m <sup>3</sup>	0.76 m <sup>3</sup>	0.76 m <sup>3</sup>	0.76 m <sup>3</sup>	0.76 m <sup>3</sup>
<b>Tip Radius</b>	1380 mm	1380 mm	1380 mm	1380 mm	1380 mm	1380 mm
<b>1</b> Maximum Digging Depth	6590 mm	6390 mm	6090 mm	5740 mm	5510 mm	5170 mm
<b>2</b> Maximum Reach at Ground Level	9160 mm	8990 mm	8780 mm	8460 mm	8970 mm	8630 mm
<b>3</b> Maximum Cutting Height	8970 mm	8880 mm	8920 mm	8740 mm	10 560 mm	10 250 mm
<b>4</b> Maximum Loading Height	6370 mm	6270 mm	6280 mm	6110 mm	7870 mm	7550 mm
<b>5</b> Minimum Loading Height	1800 mm	2000 mm	2300 mm	2650 mm	3290 mm	3590 mm
<b>6</b> Maximum Depth Cut for 2440 mm Level Bottom	6400 mm	6160 mm	5870 mm	5500 mm	5390 mm	5030 mm
<b>7</b> Maximum Vertical Wall Digging Depth	5130 mm	4940 mm	4960 mm	4520 mm	4480 mm	4100 mm



# 316F L Hydraulic Excavator Specifications

## Operating Weight and Ground Pressure

	700 mm Triple Grouser Shoes		600 mm Triple Grouser Shoes		500 mm Triple Grouser Shoes	
	kg	kPa	kg	kPa	kg	kPa
Reach Boom – 5.1 m						
R3.1 m	17 800	36.2	17 500	36.4	17 300	49.2
R2.9 m	17 800	36.2	17 500	36.4	17 300	49.2
R2.6 m	17 700	36.0	17 400	41.2	17 200	48.9
R2.25 m	17 700	36.0	17 400	41.2	17 200	48.9
Variable Angle Boom						
R2.6 m	18 500	37.6	18 200	43.1	18 000	51.2
R2.25 m	18 500	37.6	18 200	43.1	18 000	51.2

## Major Component Weights

	kg
Base Machine (with boom cylinder without counterweight, front linkage and track)	5820
Long Undercarriage	3770
Counterweight 2.8 mt	2800
Reach Boom – 5.1 m	1300
R3.1 Stick (includes lines, pins and stick cylinder)	890
R2.9 Stick (includes lines, pins and stick cylinder)	860
Variable Angle Boom	2000
R2.6 Stick (includes lines, pins, bucket cylinder and bucket linkage)	800
R2.25 Stick (includes lines, pins, bucket cylinder and bucket linkage)	770
Track Shoe (per two tracks)	
500 mm Triple Grouser	2190
600 mm Triple Grouser	2420
700 mm Triple Grouser	2660
CW dedicated Quick Coupler	220
GD 0.76 m <sup>3</sup> bucket with sidecutter and tip	560

All weights are rounded up to nearest 10 kg except for buckets.

Base machine includes 75 kg operator weight, 90% fuel weight, and undercarriage with center guard.

# 316F L Hydraulic Excavator Specifications

## Bucket and Stick Forces

Stick	Reach Boom 5.1 m			Variable Angle Boom		
	R3.1	R2.9	R2.6	R2.25	R2.6	R2.25
General Duty						
Bucket Digging Force (SAE)	98 kN	98 kN	98 kN	98 kN	98 kN	98 kN
Bucket Digging Force (ISO)	111 kN	111 kN	111 kN	111 kN	111 kN	111 kN
Stick Digging Force (SAE)	69 kN	73 kN	77 kN	85 kN	77 kN	85 kN
Stick Digging Force (ISO)	71 kN	75 kN	80 kN	88 kN	80 kN	88 kN



# 316F L Hydraulic Excavator Specifications

## Reach Boom Lift Capacities – Counterweight: 2.8 mt – without Bucket

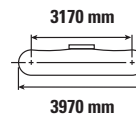
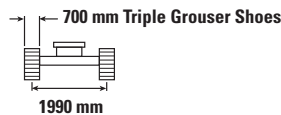
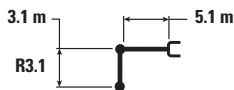

		1500 mm		3000 mm		4500 mm		6000 mm		7500 mm		mm		
7500 mm	kg											*2650	*2650	5370
6000 mm	kg							*3600	3450			*2400	*2400	6660
4500 mm	kg							*3900	3400			*2350	*2350	7430
3000 mm	kg			*7450	*7450	*5300	4950	*4450	3250	*3550	2300	*2400	2150	7850
1500 mm	kg			*8400	8250	*6750	4600	5050	3050	3600	2200	*2600	2050	7950
0 mm	kg			*7250	*7250	7550	4350	4900	2950	3550	2150	*2950	2050	7770
-1500 mm	kg	*5450	*5450	*9800	7750	7400	4250	4800	2850			*3550	2200	7280
-3000 mm	kg	*8700	*8700	*11 400	7850	7400	4250	4800	2900			4400	2650	6390
-4500 mm	kg			*9050	8100	*6150	4400					*5450	3900	4910

## Reach Boom Lift Capacities – Counterweight: 2.8 mt – without Bucket

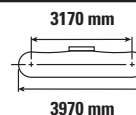
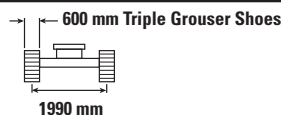

		1500 mm		3000 mm		4500 mm		6000 mm		7500 mm		mm		
7500 mm	kg											*2650	*2650	5370
6000 mm	kg							*3600	3400			*2400	*2400	6660
4500 mm	kg							*3900	3350			*2350	2350	7430
3000 mm	kg			*7450	*7450	*5300	4900	*4450	3200	*3550	2250	*2400	2100	7850
1500 mm	kg			*8400	8150	*6750	4550	4950	3050	3550	2200	*2600	2000	7950
0 mm	kg			*7250	*7250	7450	4300	4800	2900	3500	2100	*2950	2000	7770
-1500 mm	kg	*5450	*5450	*9800	7650	7300	4200	4750	2800			*3550	2200	7280
-3000 mm	kg	*8700	*8700	*11 400	7750	7300	4200	4750	2850			4350	2600	6390
-4500 mm	kg			*9050	8000	*6150	4350					*5450	3850	4910



ISO 10567



\* Indicates that the load is limited by hydraulic lifting capacity rather than tipping load. The above loads are in compliance with hydraulic excavator lift capacity standard ISO 10567:2007. They do not exceed 87% of hydraulic lifting capacity or 75% of tipping load. Weight of all lifting accessories must be deducted from the above lifting capacities. Lifting capacities are based on the machine standing on a firm, uniform supporting surface. The use of a work tool attachment point to handle/lift objects, could affect the machine lift performance.

Lift capacity stays with  $\pm 5\%$  for all available track shoes.

Always refer to the appropriate Operation and Maintenance Manual for specific product information.

# 316F L Hydraulic Excavator Specifications

## Reach Boom Lift Capacities – Counterweight: 2.8 mt – without Bucket

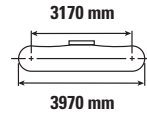
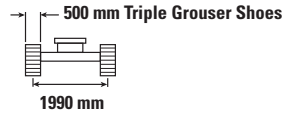
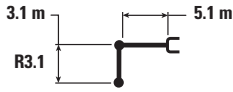

		1500 mm		3000 mm		4500 mm		6000 mm		7500 mm		mm		
														mm
7500 mm	kg											*2650	*2650	5370
6000 mm	kg							*3600	3400			*2400	*2400	6660
4500 mm	kg							*3900	3300			*2350	2300	7430
3000 mm	kg			*7450	*7450	*5300	4850	*4450	3150	*3550	2250	*2400	2050	7850
1500 mm	kg			*8400	8050	*6750	4500	4900	3000	3500	2150	*2600	1950	7950
0 mm	kg			*7250	*7250	7350	4250	4750	2850	3450	2100	*2950	2000	7770
-1500 mm	kg	*5450	*5450	*9800	7550	7200	4150	4650	2800			*3550	2150	7280
-3000 mm	kg	*8700	*8700	*11 400	7650	7250	4150	4700	2800			4300	2600	6390
-4500 mm	kg			*9050	7900	*6150	4300					*5450	3800	4910

## Reach Boom Lift Capacities – Counterweight: 2.8 mt – without Bucket

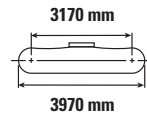
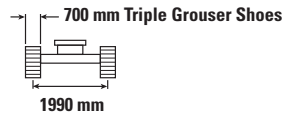
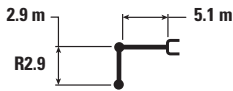

		1500 mm		3000 mm		4500 mm		6000 mm		7500 mm		mm		
														mm
7500 mm	kg											*2950	*2950	5090
6000 mm	kg							*3650	3450			*2650	*2650	6440
4500 mm	kg							*4050	3400			*2600	2500	7240
3000 mm	kg			*8000	*8000	*5550	4950	*4600	3250	*3300	2300	*2650	2200	7660
1500 mm	kg			*7100	*7100	*6950	4600	5050	3050	3600	2200	*2850	2100	7770
0 mm	kg			*7050	*7050	7550	4350	4900	2950	3550	2150	*3250	2150	7580
-1500 mm	kg	*5700	*5700	*10 100	7750	7400	4250	4800	2900			3850	2350	7070
-3000 mm	kg	*9300	*9300	*11 150	7850	7450	4250	4850	2900			4700	2800	6160
-4500 mm	kg			*8600	8150	*5750	4450					*5550	4350	4600



ISO 10567



\* Indicates that the load is limited by hydraulic lifting capacity rather than tipping load. The above loads are in compliance with hydraulic excavator lift capacity standard ISO 10567:2007. They do not exceed 87% of hydraulic lifting capacity or 75% of tipping load. Weight of all lifting accessories must be deducted from the above lifting capacities. Lifting capacities are based on the machine standing on a firm, uniform supporting surface. The use of a work tool attachment point to handle/lift objects, could affect the machine lift performance.

Lift capacity stays with  $\pm 5\%$  for all available track shoes.

Always refer to the appropriate Operation and Maintenance Manual for specific product information.



# 316F L Hydraulic Excavator Specifications

## Reach Boom Lift Capacities – Counterweight: 2.8 mt – without Bucket

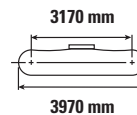
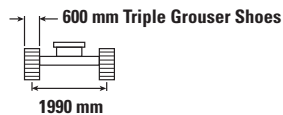
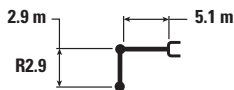

		1500 mm		3000 mm		4500 mm		6000 mm		7500 mm		mm		
7500 mm	kg											*2950	*2950	5090
6000 mm	kg							*3650	3400			*2650	*2650	6440
4500 mm	kg							*4050	3350			*2600	2450	7240
3000 mm	kg			*8000	*8000	*5550	4900	*4600	3200	*3300	2250	*2650	2200	7660
1500 mm	kg			*7100	*7100	*6950	4500	4950	3050	3550	2200	*2850	2100	7770
0 mm	kg			*7050	*7050	7450	4300	4800	2900	3500	2150	*3250	2100	7580
-1500 mm	kg	*5700	*5700	*10 100	7650	7300	4200	4750	2850			3800	2300	7070
-3000 mm	kg	*9300	*9300	*11 150	7750	7350	4200	4800	2850			4600	2800	6160
-4500 mm	kg			*8600	8050	*5750	4400					*5550	4250	4600

## Reach Boom Lift Capacities – Counterweight: 2.8 mt – without Bucket

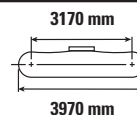
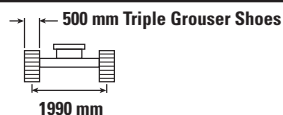

		1500 mm		3000 mm		4500 mm		6000 mm		7500 mm		mm		
7500 mm	kg											*2950	*2950	5090
6000 mm	kg							*3650	3350			*2650	*2650	6440
4500 mm	kg							*4050	3300			*2600	2400	7240
3000 mm	kg			*8000	*8000	*5550	4850	*4600	3150	*3300	2250	*2650	2150	7660
1500 mm	kg			*7100	*7100	*6950	4450	4900	3000	3500	2150	*2850	2050	7770
0 mm	kg			*7050	*7050	7350	4250	4750	2850	3450	2100	*3250	2100	7580
-1500 mm	kg	*5700	*5700	*10 100	7550	7200	4150	4700	2800			3750	2250	7070
-3000 mm	kg	*9300	*9300	*11 150	7700	7250	4150	4700	2850			4550	2750	6160
-4500 mm	kg			*8600	7950	*5750	4350					*5550	4200	4600



ISO 10567



\* Indicates that the load is limited by hydraulic lifting capacity rather than tipping load. The above loads are in compliance with hydraulic excavator lift capacity standard ISO 10567:2007. They do not exceed 87% of hydraulic lifting capacity or 75% of tipping load. Weight of all lifting accessories must be deducted from the above lifting capacities. Lifting capacities are based on the machine standing on a firm, uniform supporting surface. The use of a work tool attachment point to handle/lift objects, could affect the machine lift performance.

Lift capacity stays with  $\pm 5\%$  for all available track shoes.

Always refer to the appropriate Operation and Maintenance Manual for specific product information.

# 316F L Hydraulic Excavator Specifications

## Reach Boom Lift Capacities – Counterweight: 2.8 mt – without Bucket

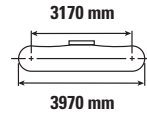
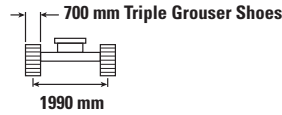
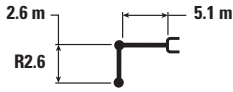

		1500 mm		3000 mm		4500 mm		6000 mm		7500 mm		mm		
7500 mm	kg											*3250	*3250	4760
6000 mm	kg							*3500	3400			*2850	*2850	6180
4500 mm	kg					*4650	*4650	*4300	3350			*2750	2600	7010
3000 mm	kg			*8900	*8900	*5900	4900	*4850	3250			*2850	2300	7450
1500 mm	kg					*7250	4550	5050	3100	*3400	2250	*3000	2200	7560
0 mm	kg			*6250	*6250	7550	4350	4900	2950			*3400	2250	7370
-1500 mm	kg	*5750	*5750	*10 150	7900	7450	4300	4850	2900			4050	2450	6840
-3000 mm	kg	*9950	*9950	*10 800	8000	*7450	4350					5050	3050	5890
-4500 mm	kg			*7800	*7800							*5450	4950	4230

## Reach Boom Lift Capacities – Counterweight: 2.8 mt – without Bucket

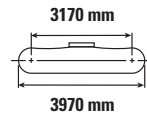
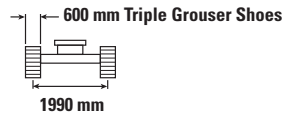
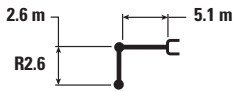

		1500 mm		3000 mm		4500 mm		6000 mm		7500 mm		mm		
7500 mm	kg											*3250	*3250	4760
6000 mm	kg							*3500	3350			*2850	*2850	6180
4500 mm	kg					*4650	*4650	*4300	3300			*2750	2600	7010
3000 mm	kg			*8900	8850	*5900	4850	*4850	3200			*2850	2300	7450
1500 mm	kg					*7250	4500	4950	3050	*3400	2200	*3000	2200	7560
0 mm	kg			*6250	*6250	7450	4300	4850	2950			*3400	2200	7370
-1500 mm	kg	*5750	*5750	*10 150	7800	7350	4250	4800	2900			4000	2450	6840
-3000 mm	kg	*9950	*9950	*10 800	7900	7400	4300					5000	3000	5890
-4500 mm	kg			*7800	*7800							*5450	4900	4230



ISO 10567



\* Indicates that the load is limited by hydraulic lifting capacity rather than tipping load. The above loads are in compliance with hydraulic excavator lift capacity standard ISO 10567:2007. They do not exceed 87% of hydraulic lifting capacity or 75% of tipping load. Weight of all lifting accessories must be deducted from the above lifting capacities. Lifting capacities are based on the machine standing on a firm, uniform supporting surface. The use of a work tool attachment point to handle/lift objects, could affect the machine lift performance.

Lift capacity stays with ±5% for all available track shoes.

Always refer to the appropriate Operation and Maintenance Manual for specific product information.



# 316F L Hydraulic Excavator Specifications

## Reach Boom Lift Capacities – Counterweight: 2.8 mt – without Bucket

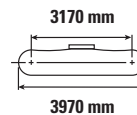
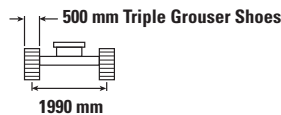
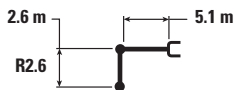

Reach (mm)	Unit	1500 mm		3000 mm		4500 mm		6000 mm		7500 mm		mm		
7500 mm	kg											*3250	*3250	4760
6000 mm	kg							*3500	3300			*2850	*2850	6180
4500 mm	kg					*4650	*4650	*4300	3300			*2750	2550	7010
3000 mm	kg			*8900	8750	*5900	4800	*4850	3150			*2850	2250	7450
1500 mm	kg					*7250	4450	4900	3000	*3400	2200	*3000	2150	7560
0 mm	kg			*6250	*6250	7350	4250	4800	2900			*3400	2200	7370
-1500 mm	kg	*5750	*5750	*10 150	7700	7300	4200	4750	2850			3950	2400	6840
-3000 mm	kg	*9950	*9950	*10 800	7800	7350	4250					4900	2950	5890
-4500 mm	kg			*7800	*7800							*5450	4850	4230

## Reach Boom Lift Capacities – Counterweight: 2.8 mt – without Bucket

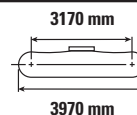
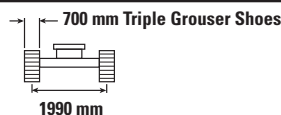

Reach (mm)	Unit	1500 mm		3000 mm		4500 mm		6000 mm		mm		
7500 mm	kg									*3950	*3950	4230
6000 mm	kg									*3400	*3400	5790
4500 mm	kg					*5000	*5000	*4600	3300	*3250	2800	6670
3000 mm	kg					*6250	4850	*5050	3200	*3350	2450	7130
1500 mm	kg					*7500	4550	5000	3050	*3550	2350	7250
0 mm	kg			*5600	*5600	7550	4350	4900	2950	3900	2400	7040
-1500 mm	kg	*6100	*6100	*10 800	7950	7500	4300	4850	2950	4400	2650	6490
-3000 mm	kg			*10 200	8100	*7150	4400			*5600	3400	5480



ISO 10567



\* Indicates that the load is limited by hydraulic lifting capacity rather than tipping load. The above loads are in compliance with hydraulic excavator lift capacity standard ISO 10567:2007. They do not exceed 87% of hydraulic lifting capacity or 75% of tipping load. Weight of all lifting accessories must be deducted from the above lifting capacities. Lifting capacities are based on the machine standing on a firm, uniform supporting surface. The use of a work tool attachment point to handle/lift objects, could affect the machine lift performance.









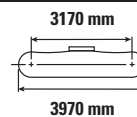
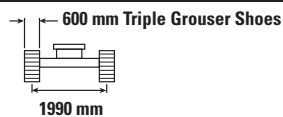

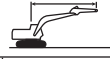
Lift capacity stays with  $\pm 5\%$  for all available track shoes.

Always refer to the appropriate Operation and Maintenance Manual for specific product information.

# 316F L Hydraulic Excavator Specifications









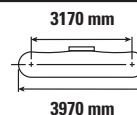
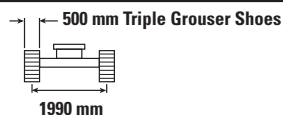

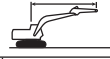
## Reach Boom Lift Capacities – Counterweight: 2.8 mt – without Bucket



		1500 mm		3000 mm		4500 mm		6000 mm				mm
												
7500 mm	kg									*3950	*3950	4230
6000 mm	kg									*3400	*3400	5790
4500 mm	kg					*5000	*5000	*4600	3300	*3250	2750	6670
3000 mm	kg					*6250	4800	*5050	3150	*3350	2450	7130
1500 mm	kg					*7500	4450	4950	3000	*3550	2300	7250
0 mm	kg			*5600	*5600	7450	4300	4850	2950	3850	2350	7040
-1500 mm	kg	*6100	*6100	*10 800	7850	7400	4250	4800	2900	4300	2650	6490
-3000 mm	kg			*10 200	8000	*7150	4350			5550	3350	5480

## Reach Boom Lift Capacities – Counterweight: 2.8 mt – without Bucket



		1500 mm		3000 mm		4500 mm		6000 mm				mm
												
7500 mm	kg									*3950	*3950	4230
6000 mm	kg									*3400	*3400	5790
4500 mm	kg					*5000	*5000	*4600	3250	*3250	2750	6670
3000 mm	kg					*6250	4700	5050	3100	*3350	2400	7130
1500 mm	kg					*7500	4400	4900	3000	*3550	2300	7250
0 mm	kg			*5600	*5600	7350	4250	4800	2900	3800	2350	7040
-1500 mm	kg	*6100	*6100	*10 800	7750	7300	4200	4750	2850	4250	2600	6490
-3000 mm	kg			*10 200	7900	*7150	4300			5500	3300	5480



ISO 10567



\* Indicates that the load is limited by hydraulic lifting capacity rather than tipping load. The above loads are in compliance with hydraulic excavator lift capacity standard ISO 10567:2007. They do not exceed 87% of hydraulic lifting capacity or 75% of tipping load. Weight of all lifting accessories must be deducted from the above lifting capacities. Lifting capacities are based on the machine standing on a firm, uniform supporting surface. The use of a work tool attachment point to handle/lift objects, could affect the machine lift performance.

Lift capacity stays with  $\pm 5\%$  for all available track shoes.









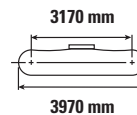
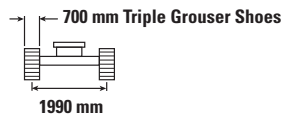
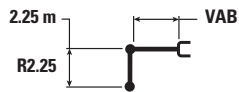

Always refer to the appropriate Operation and Maintenance Manual for specific product information.



# 316F L Hydraulic Excavator Specifications









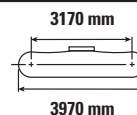
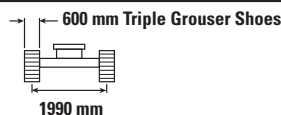

## Variable Angle Boom Lift Capacities – Counterweight: 2.8 mt – without Bucket



		1500 mm		3000 mm		4500 mm		6000 mm				mm
												
7500 mm	kg			*5900	*5900	*4200	*4200			*4100	*4100	4530
6000 mm	kg			*5700	*5700	*3550	*3550	*3550	3250	*3500	3250	6010
4500 mm	kg			*6750	*6750	*4700	*4700	*3450	3250	*3350	2600	6860
3000 mm	kg			*7400	*7400	*5900	4700	*3600	3100	*3350	2300	7300
1500 mm	kg			*6650	*6650	*7600	4350	*4300	2950	*3500	2150	7420
0 mm	kg			*5850	*5850	7400	4150	4800	2850	3700	2250	7220
-1500 mm	kg	*9100	*9100	*9000	7650	7400	4150	4800	2800	4150	2500	6680
-3000 mm	kg	*16 050	*16 050	*9100	7850	*5850	4250			*4850	3450	5300

## Variable Angle Boom Lift Capacities – Counterweight: 2.8 mt – without Bucket



		1500 mm		3000 mm		4500 mm		6000 mm				mm
												
7500 mm	kg			*5900	*5900	*4200	*4200			*4100	*4100	4530
6000 mm	kg			*5700	*5700	*3550	*3550	*3550	3250	*3500	3200	6010
4500 mm	kg			*6750	*6750	*4700	*4700	*3450	3200	*3350	2550	6860
3000 mm	kg			*7400	*7400	*5900	4650	*3600	3050	*3350	2250	7300
1500 mm	kg			*6650	*6650	7500	4300	*4300	2900	*3500	2150	7420
0 mm	kg			*5850	*5850	7300	4100	4750	2800	3650	2200	7220
-1500 mm	kg	*9100	*9100	*9000	7550	7300	4100	4750	2800	4100	2450	6680
-3000 mm	kg	*16 050	*16 050	*9100	7750	*5850	4200			*4850	3400	5300



ISO 10567



\* Indicates that the load is limited by hydraulic lifting capacity rather than tipping load. The above loads are in compliance with hydraulic excavator lift capacity standard ISO 10567:2007. They do not exceed 87% of hydraulic lifting capacity or 75% of tipping load. Weight of all lifting accessories must be deducted from the above lifting capacities. Lifting capacities are based on the machine standing on a firm, uniform supporting surface. The use of a work tool attachment point to handle/lift objects, could affect the machine lift performance.







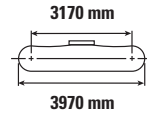
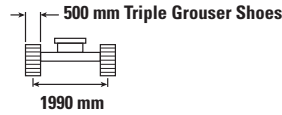
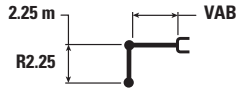

Lift capacity stays with ±5% for all available track shoes.

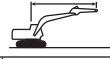
Always refer to the appropriate Operation and Maintenance Manual for specific product information.

# 316F L Hydraulic Excavator Specifications







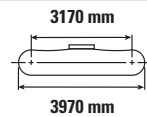
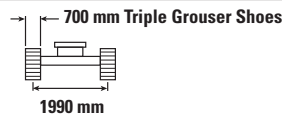
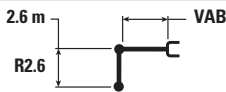

## Variable Angle Boom Lift Capacities – Counterweight: 2.8 mt – without Bucket



		1500 mm		3000 mm		4500 mm		6000 mm				mm
												
7500 mm	kg			*5900	*5900	*4200	*4200			*4100	*4100	4530
6000 mm	kg			*5700	*5700	*3550	*3550	*3550	3200	*3500	3200	6010
4500 mm	kg			*6750	*6750	*4700	*4700	*3450	3150	*3350	2500	6860
3000 mm	kg			*7400	*7400	*5900	4600	*3600	3000	*3350	2200	7300
1500 mm	kg			*6650	*6650	7450	4250	*4300	2850	*3500	2100	7420
0 mm	kg			*5850	*5850	7200	4050	4700	2750	3650	2150	7220
-1500 mm	kg	*9100	*9100	*9000	7450	7200	4050	4700	2750	4050	2400	6680
-3000 mm	kg	*16 050	*16 050	*9100	7650	*5850	4150			*4850	3350	5300

## Variable Angle Boom Lift Capacities – Counterweight: 2.8 mt – without Bucket



		1500 mm		3000 mm		4500 mm		6000 mm		7500 mm				mm
														
9000 mm	kg											*5300	*5300	2240
7500 mm	kg			*5350	*5350	*3450	*3450					*3450	*3450	5050
6000 mm	kg			*4800	*4800	*3950	*3950	*3000	*3000			*3000	2950	6410
4500 mm	kg			*5950	*5950	*4200	*4200	*3000	*3000			*2900	2400	7210
3000 mm	kg			*6600	*6600	*5350	4800	*3450	3150	*2950	2200	*2900	2150	7630
1500 mm	kg			*6800	*6800	*7150	4400	*4800	2950	*3250	2150	*3050	2050	7750
0 mm	kg	*5150	*5150	*5450	*5450	7400	4200	*4600	2850	*3400	2100	*3300	2100	7560
-1500 mm	kg	*7400	*7400	*9200	7600	7350	4100	4800	2800			3850	2300	7050
-3000 mm	kg	*13 050	*13 050	*9100	7750	*5750	4200					*4300	2950	5890



ISO 10567



\* Indicates that the load is limited by hydraulic lifting capacity rather than tipping load. The above loads are in compliance with hydraulic excavator lift capacity standard ISO 10567:2007. They do not exceed 87% of hydraulic lifting capacity or 75% of tipping load. Weight of all lifting accessories must be deducted from the above lifting capacities. Lifting capacities are based on the machine standing on a firm, uniform supporting surface. The use of a work tool attachment point to handle/lift objects, could affect the machine lift performance.

Lift capacity stays with  $\pm 5\%$  for all available track shoes.

Always refer to the appropriate Operation and Maintenance Manual for specific product information.

# 316F L Hydraulic Excavator Specifications

## Variable Angle Boom Lift Capacities – Counterweight: 2.8 mt – without Bucket

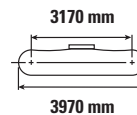
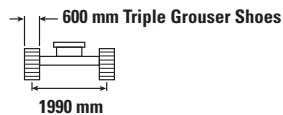
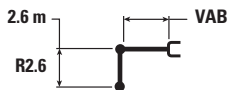

		1500 mm		3000 mm		4500 mm		6000 mm		7500 mm		mm		
9000 mm	kg											*5300	*5300	2240
7500 mm	kg			*5350	*5350	*3450	*3450					*3450	*3450	5050
6000 mm	kg			*4800	*4800	*3950	*3950	*3000	*3000			*3000	2950	6410
4500 mm	kg			*5950	*5950	*4200	*4200	*3000	*3000			*2900	2350	7210
3000 mm	kg			*6600	*6600	*5350	4750	*3450	3100	*2950	2200	*2900	2100	7630
1500 mm	kg			*6800	*6800	*7150	4350	*4800	2900	*3250	2100	*3050	2000	7750
0 mm	kg	*5150	*5150	*5450	*5450	7300	4150	*4600	2800	*3400	2050	*3300	2050	7560
-1500 mm	kg	*7400	*7400	*9200	7500	7250	4050	4700	2750			3800	2250	7050
-3000 mm	kg	*13 050	*13 050	*9100	7650	*5750	4150					*4300	2900	5890

## Variable Angle Boom Lift Capacities – Counterweight: 2.8 mt – without Bucket

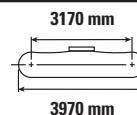
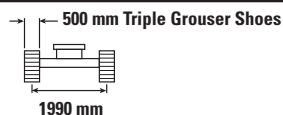
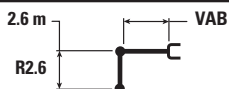

		1500 mm		3000 mm		4500 mm		6000 mm		7500 mm		mm		
9000 mm	kg											*5300	*5300	2240
7500 mm	kg			*5350	*5350	*3450	*3450					*3450	*3450	5050
6000 mm	kg			*4800	*4800	*3950	*3950	*3000	*3000			*3000	2900	6410
4500 mm	kg			*5950	*5950	*4200	*4200	*3000	*3000			*2900	2350	7210
3000 mm	kg			*6600	*6600	*5350	4700	*3450	3050	*2950	2150	*2900	2100	7630
1500 mm	kg			*6800	*6800	*7150	4300	*4800	2900	*3250	2100	*3050	2000	7750
0 mm	kg	*5150	*5150	*5450	*5450	7250	4050	*4600	2750	*3400	2050	*3300	2000	7560
-1500 mm	kg	*7400	*7400	*9200	7400	7150	4000	4650	2700			3750	2250	7050
-3000 mm	kg	*13 050	*13 050	*9100	7550	*5750	4100					*4300	2900	5890



ISO 10567



\* Indicates that the load is limited by hydraulic lifting capacity rather than tipping load. The above loads are in compliance with hydraulic excavator lift capacity standard ISO 10567:2007. They do not exceed 87% of hydraulic lifting capacity or 75% of tipping load. Weight of all lifting accessories must be deducted from the above lifting capacities. Lifting capacities are based on the machine standing on a firm, uniform supporting surface. The use of a work tool attachment point to handle/lift objects, could affect the machine lift performance.

Lift capacity stays with  $\pm 5\%$  for all available track shoes.

Always refer to the appropriate Operation and Maintenance Manual for specific product information.



# 316F L Hydraulic Excavator Specifications

## Work Tool Offering Guide\* – Europe

Boom Type	Reach Boom		VA Boom	
Stick Size	R2.6	R2.25	R2.6	R2.25
Hydraulic Hammer	H110Es H115Es H120Es	H110Es H115Es H120Es	H110Es H115Es H120Es	H110Es H115Es H120Es
Crusher		P315		
Pulverizer	P215	P215		
Demolition & Sorting Grapple (D – Demolition shells, R – Recycling shells, CAN – fixed hingeplates for CW quick coupler usage)	G310B-D/R G310B-D/R CAN G313 GC G313 GC CAN G315 GC G315 GC CAN  G315B WH	G310B-D/R G310B-D/R CAN G313 GC G313 GC CAN G315 GC G315 GC CAN G315B-D/R G315B WH	G310B-D/R G310B-D/R CAN	G310B-D/R G310B-D/R CAN G313 GC G313 GC CAN G315 GC
Demolition & Sorting Grapple for RT60 Rototilt	G213 GC	G213 GC		
Scrap & Demolition Shear	S325	S325	S325	S325
Compactor (Vibratory Plate)	CVP75	CVP75	CVP75	CVP75
Orange Peel Grapple				
Pin Grabber Coupler	Cat-PG			
Dedicated Quick Coupler	CW-30 CW-30S CWAC-40 (autoconnect)			

These work tools are available for the 316F L.  
Consult your Cat dealer for proper match.

\*Offerings not available in all areas. Matches are dependent on excavator configurations. Consult your Cat dealer to determine what is offered in your area and for proper work tool match.

# 316F L Hydraulic Excavator Specifications

## Work Tool Offering Guide\* – Australia/New Zealand

<b>Boom Type</b>	<b>Reach Boom</b>			
<b>Stick Size</b>	<b>R3.1</b>	<b>R2.9</b>	<b>R2.6</b>	<b>R2.25</b>
Hydraulic Hammer	H110Es H115Es H120Es	H110Es H115Es H120Es	H110Es H115Es H120Es	H110Es H115Es H120Es
Multi-Processor				MP15 CC Jaw MP15 CR Jaw MP15 PS Jaw MP15 S Jaw
Crusher				P315
Pulverizer				P215
Demolition & Sorting Grapple	G310B	G310B	G310B	G310B G315B
Mobile Scrap & Demolition Shear	S325	S325	S325	S325
Compactor (Vibratory Plate)	CVP75	CVP75	CVP75	CVP75
Contractors' Grapple	G115B	G115B	G115B	G115B
Orange Peel Grapple				
Trash Grapple				
Thumbs				
Rakes				
Center-Lock™ Pin Grabber Coupler				
Dedicated Quick Coupler				

These work tools are available for the 316F L.  
Consult your Cat dealer for proper match.

\* Offerings not available in all areas. Matches are dependent on excavator configurations. Consult your Cat dealer to determine what is offered in your area and for proper work tool match.

# 316F L Hydraulic Excavator Specifications

## Bucket Specifications and Compatibility – Europe

	Width	Capacity	Weight	Fill	Reach Boom		VA Boom	
	mm	m <sup>3</sup>	kg	%	R2.25	R2.6	R2.25	R2.6
<b>Without Quick Coupler</b>								
General Duty (GD)	1100	0.80	601	100%	●	●	⊙	⊙
	1300	1.00	682	100%	X	X	⊖	○
	1400	1.09	712	100%	X	X	○	○
Severe Duty (SD)	1200	0.91	722	90%	⊙	⊙	⊖	⊖
Maximum load pin-on (payload + bucket)				kg	2375	2205	2120	1965
<b>With Pin Grabber Quick Coupler</b>								
General Duty (GD)	1100	0.80	601	100%	⊙	⊖	○	○
	1300	1.00	682	100%	○	◇	◇	◇
	1400	1.09	712	100%	○	◇	◇	◇
Severe Duty (SD)	1200	0.91	722	90%	⊖	○	○	◇
Maximum load with coupler (payload + bucket)				kg	1985	1815	1730	1575
<b>With CW Dedicated Quick Coupler (CW30/CW30s)</b>								
General Duty (GD)	600	0.35	431	100%	●	●	●	●
	750	0.49	464	100%	●	●	●	●
	900	0.62	524	100%	●	●	●	⊙
	1100	0.79	583	100%	⊙	⊙	⊖	⊖
	1200	0.91	633	100%	⊖	⊖	○	○
	1300	1.00	663	100%	⊖	○	○	◇
	1400	1.09	693	100%	X	X	◇	◇
Heavy Duty (HD)	1200	0.91	649	100%	⊖	⊖	○	○
	1300	1.00	681	100%	⊖	○	○	◇
	1400	1.09	712	100%	X	X	◇	◇
Maximum load with coupler (payload + bucket)				kg	2155	1985	1900	1745

The above loads are in compliance with hydraulic excavator standard EN474, they do not exceed 87% of hydraulic lifting capacity or 75% of tipping capacity with front linkage fully extended at ground line with bucket curled.

Capacity based on ISO 7451.

Bucket weight with General Duty tips.

### Maximum Material Density:

- 2100 kg/m<sup>3</sup>
- ⊙ 1800 kg/m<sup>3</sup>
- ⊖ 1500 kg/m<sup>3</sup>
- 1200 kg/m<sup>3</sup>
- ◇ 900 kg/m<sup>3</sup>
- X Not Recommended

Caterpillar recommends using appropriate work tools to maximize the value customers receive from our products. Use of work tools, including buckets, which are outside of Caterpillar's recommendations or specifications for weight, dimensions, flows, pressures, etc. may result in less-than-optimal performance, including but not limited to reductions in production, stability, reliability, and component durability. Improper use of a work tool resulting in sweeping, prying, twisting and/or catching of heavy loads will reduce the life of the boom and stick.



# 316F L Hydraulic Excavator Specifications

## Bucket Specifications and Compatibility – Australia/New Zealand

	Width	Capacity	Weight	Fill	Reach Boom		
	mm	m <sup>3</sup>	kg	%	R2.25	R2.6	R2.9
<b>With Pin Grabber Quick Coupler</b>							
General Duty (GD)	500	0.30	403	100%	●	●	●
	600	0.35	433	100%	●	●	●
	750	0.49	476	100%	●	●	●
	900	0.62	537	100%	●	●	⊙
	1050	0.76	590	100%	⊙	⊖	⊖
	1200	0.91	645	100%	⊖	○	○
Maximum load with coupler (payload + bucket)				kg	1950	1815	1705

The above loads are in compliance with hydraulic excavator standard EN474, they do not exceed 87% of hydraulic lifting capacity or 75% of tipping capacity with front linkage fully extended at ground line with bucket curled.

Capacity based on ISO 7451.

Bucket weight with General Duty tips.

### Maximum Material Density:

- 2100 kg/m<sup>3</sup>
- ⊙ 1800 kg/m<sup>3</sup>
- ⊖ 1500 kg/m<sup>3</sup>
- 1200 kg/m<sup>3</sup>

Caterpillar recommends using appropriate work tools to maximize the value customers receive from our products. Use of work tools, including buckets, which are outside of Caterpillar's recommendations or specifications for weight, dimensions, flows, pressures, etc. may result in less-than-optimal performance, including but not limited to reductions in production, stability, reliability, and component durability. Improper use of a work tool resulting in sweeping, prying, twisting and/or catching of heavy loads will reduce the life of the boom and stick.

# 316F L Standard Equipment

## Standard Equipment

Standard equipment may vary. Consult your Cat dealer for details.

### ENGINE

- C4.4 ACERT diesel engine
- Biodiesel capable
- Meets Tier 4 Final and EU Stage IV emission standards
- 2300 m altitude capability
- Electric priming pump
- Automatic engine speed control
- Economy and high power modes
- Two-speed travel
- Side-by-side cooling system
- Radial seal air filter
- Primary filter with water separator and water separator indicator
- Secondary filter
- Screen filter in fuel line
- Cold weather battery –25° C
- Jump start receptacle
- Ambient capability, 52° C

### HYDRAULIC SYSTEM

- Regeneration circuit for boom and stick
- Reverse swing dampening valve
- Automatic swing parking brake
- High-performance hydraulic return filter

### CAB

- Pressurized operator station with positive filtration
- Sliding upper door window
- Radial wiper and washer
- Glass-breaking safety hammer
- Removable lower windshield with in cab storage bracket
- Coat hook
- Beverage holder
- Literature holder
- Seat belt, 51 mm
- Two 12V stereo speakers
- Storage shelf suitable for lunch or toolbox
- Color LCD display with indicators, filter/fluid change, and working hour information
- Adjustable armrest
- Height adjustable joystick consoles
- Neutral lever (lock out) for all controls
- Travel control pedals with removable hand levers
- Two power outlets, 10 amp (total)
- Laminated glass front upper window and tempered other windows
- Seat, high-back air suspension with heater
- Air pre-filter

### UNDERCARRIAGE

- Grease Lubricated Track GLT2, resin seal
- Towing eye on base frame
- Swivel guard

### COUNTERWEIGHT

- 2.8 mt

### ELECTRICAL

- 80 amp alternator
- Circuit breaker
- Capability to electronically connect a beacon

### LIGHTS

- Working lights, cab and boom mounted with time delay function
- Exterior lights integrated into storage box

### SECURITY

- Cat one key security system
- Door locks
- Cap locks on fuel and hydraulic tanks
- Lockable external tool/storage box
- Signaling/warning horn
- Secondary engine shutoff switch
- Openable skylight for emergency exit
- Rearview camera

### TECHNOLOGY

- Product Link

## Optional Equipment

Optional equipment may vary. Consult your Cat dealer for details.

### ENGINE

- Quick drains, engine and hydraulic oil
- Battery, cold weather
- Electric refueling pump

### HYDRAULIC SYSTEM

- Control pattern quick-changer, two way
- Auxiliary hydraulics
- Boom and stick High Pressure lines
- Boom and stick Medium Pressure lines
- Boom, stick and bucket QC lines

### CAB

- Left foot switch
- Left pedal
- Straight travel pedal
- Rain protector
- AM/FM radio
- Radio with MP3 auxiliary audio port
- Travel alarm
- Sunscreen

### UNDERCARRIAGE

- 500 mm (20") triple grouser shoes
- 600 mm triple grouser shoes
- 700 mm triple grouser shoes
- Full-length track guiding guard
- Heavy duty bottom guard
- Center track guiding guard
- Segmented (2 piece) track guiding guard

### FRONT LINKAGE

- Reach boom, 5.1 m (with BLCV, SLCV)
  - 3.1 m stick
  - 2.9 m stick
  - 2.6 m stick (with/without Grade Control)
  - 2.25 m stick
- Variable Angle boom (with BLCV, SLCV)
  - 2.6 m stick (with/without Grade Control)
  - 2.25 m stick
- Bucket linkage (with lifting eye)
- CW dedicated and Pin Grabber quick couplers

### SECURITY

- FOGS (Falling Object Guard), bolt-on
- Side steel bumper
- Right side view camera

### TECHNOLOGY

- Cat Grade Control Depth and Slope



For more complete information on Cat products, dealer services, and industry solutions, visit us on the web at [www.cat.com](http://www.cat.com)

AEHQ7812 (05-2016)  
(ANZ, EU)

© 2016 Caterpillar  
All rights reserved

Materials and specifications are subject to change without notice. Featured machines in photos may include additional equipment. See your Cat dealer for available options.

CAT, CATERPILLAR, SAFETY.CAT.COM, their respective logos, "Caterpillar Yellow" and the "Power Edge" trade dress, as well as corporate and product identity used herein, are trademarks of Caterpillar and may not be used without permission.

VisionLink is a trademark of Trimble Navigation Limited, registered in the United States and in other countries.

