

315F L

Hydraulic Excavator



Engine

Engine Model	Cat® C4.4 ACERT™
Engine Power – ISO 14396	74 kW (101 PS)
Net Power – ISO 9249/SAE J1349	72 kW (98 PS)

Drive

Maximum Travel Speed	5.5 km/h
Maximum Drawbar Pull	112 kN

Weight

Minimum Operating Weight	15 040 kg
Maximum Operating Weight	17 300 kg

Introduction

The new Cat 315F compact radius excavator features a U.S. EPA Tier 4 Final and EU Stage IV emission standards C4.4 ACERT engine. It's miserly on fuel paired with a state-of-the-art hydraulic system that's responsive to your every command. Each pull of the joysticks will feel like a natural extension of yourself, providing you with smooth, controlled power to take on the work in front of you with speed, precision, and confidence.

When you add in robust structures that keep you grounded and balanced, an operator environment that enhances your comfort and productivity, service points that make your routine maintenance fast and simple, available Cat Grade Control to help you create precise planes and slopes with ease, and multiple Cat work tools and tool control system that enable you to quickly take on a variety of tasks, you simply won't find a better built, more reliable, more versatile, or more rewarding excavator in its size class – from any company, anywhere.

Bottom line: If your work takes you in to tight spaces and you need the absolute best performance at the lowest cost per unit of work that you can possibly get from a 15-ton excavator, take along a Cat 315F. You will be glad you did.

Contents

Hydraulics	4
Engine	6
Compact Radius	7
Operator Station.....	8
Attachments.....	9
Integrated Technologies.....	10
Front Linkage	12
Structures & Undercarriage	13
Serviceability.....	14
Safety	15
Complete Customer Care.....	16
Sustainability	17
Specifications.....	18
Standard Equipment.....	34
Optional Equipment.....	35





Hydraulics

You can move dirt, rock, and debris with speed, precision, and efficiency





A Forceful, Responsive Design

The 315F features a negative flow control hydraulic system that gives you the feel and response of an open center valve system with the efficiency of a closed center valve system. In layman's terms, negative flow control decreases pump flow when oil pressure in the center bypass increases and vice versa. The net result is the pump and valve operate in harmony with less energy and less wear and tear.

A Logical Layout

All major hydraulic components are strategically located close together. This positioning leads to reduced friction loss and pressure drops, and the result is more hydraulic horsepower for the heavy-lifting, ground-breaking work you need to get done.

Valves For Added Efficiency

The 315F is built with a back-to-back main control valve, and the benefit to you is reduced pressure loss and fuel consumption due to the shorter distance oil has to travel. The machine also features special boom and stick valves that recirculate oil flow in the cylinders during work instead of going all the way back to the tank. The valves contribute to energy savings, but their primary benefit is allowing more oil to flow to other functions so you can experience faster cycle times and more production.

Filter For Added Protection & Performance

The capsule filter is designed to take out impurities and help you avoid system contamination and accidental spilling. The self-contained, maintenance-friendly filter is easy to remove with a simple wrench. It can take out impurities as small as beta 10 – particles so tiny you cannot see them with the eye. A sensor lets you know if there is a clog or if pressure exceeds a certain level so you can take action.

Drain Filter

A drain filter is one extra level of contamination prevention the 315F offers. Located in the pump compartment behind the pilot filter, the drain filter purifies the case drain from the main pumps, swing motor, and travel motors – all to enhance the life of the pumps and motors and uptime for you.

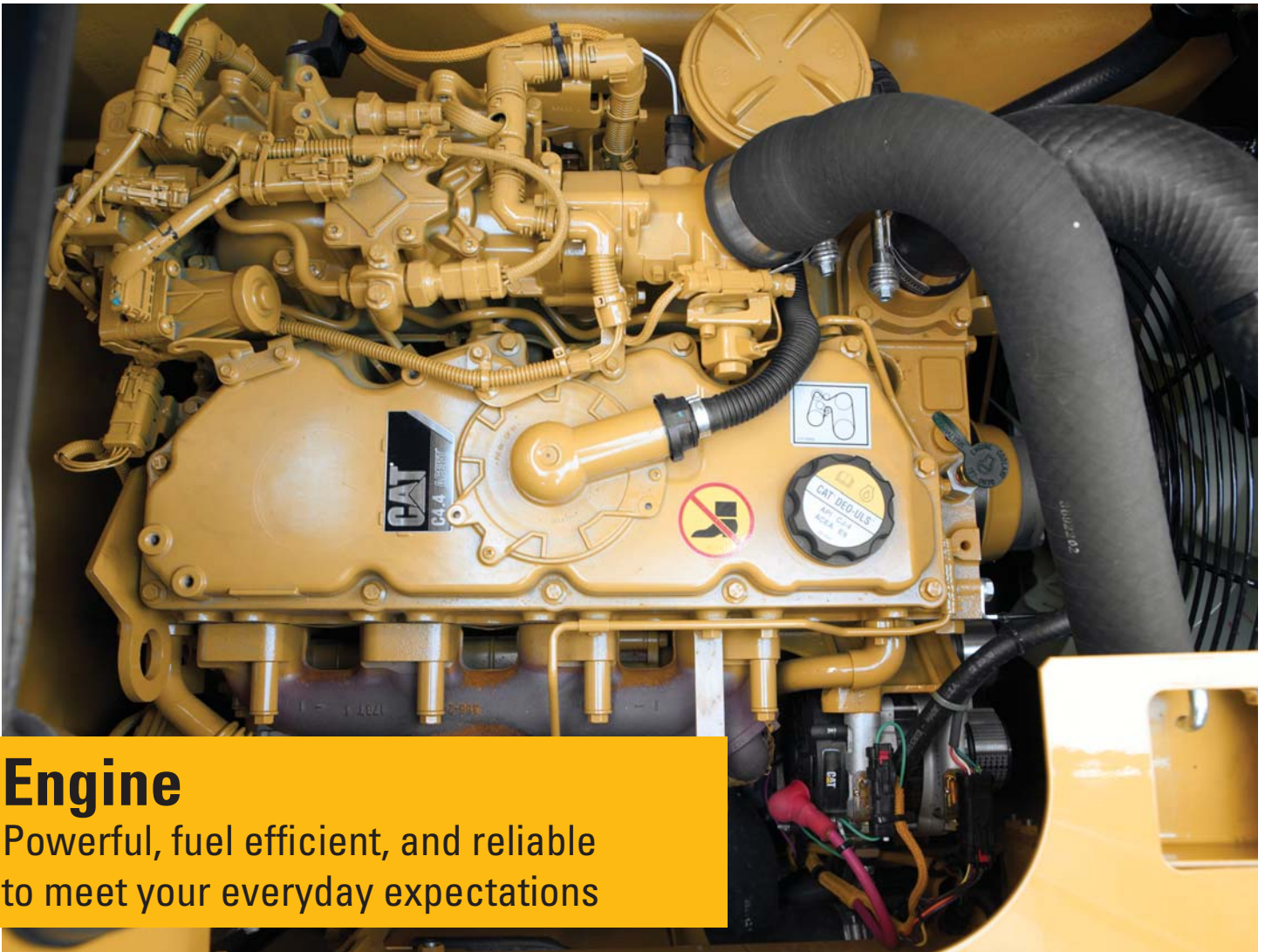

Engine

Powerful, fuel efficient, and reliable to meet your everyday expectations

Proven Technology

Every Tier 4 Final and Stage IV ACERT engine is equipped with a combination of proven electronic, fuel, air, and aftertreatment components. Applying these time-tested technologies lets us meet your high expectations for productivity, fuel efficiency, reliability, and service life.

Following are the results you can expect:

- High performance across a variety of applications.
- Enhanced reliability through commonality and simplicity of design.
- Maximized uptime and reduced cost with world-class Cat dealer support.
- Minimized impact on emission systems – with no operator interaction required.
- Durability with long service life.
- Same great power and response.
- Biodiesel capability to give you more potential fuel-saving flexibility.

Compact Radius

Sized right for tight quarters work



Work With Confidence

The 315F L's compact radius design makes it ideal for working confidently in space-restricted areas like road jobs with lane closures and next to buildings or other structures you'd like to keep from harm's way. With a front swing radius of 2.27 m and a tail swing radius of 1530 mm, the machine can dig, swing, and dump within a working space of 3.8 m. When rotated 90 degrees and working over the side, just 135 mm of counterweight extends beyond the track width, which allows trucks and jersey barriers to be positioned closer to the machine.

Work With Power

Unlike a standard radius machine, the 315F's boom is positioned toward the center of the machine. Not only does this help reduce the front swing radius, but it also supports more lift capacity over the front due to greater stability.

Work With Comfort

The machine features a full-size ROPS-certified cab. With low sound levels, high visibility, convenient access to switches and controls, and a fully adjustable seat, you will find it comfortable to work in all day long.

Operator Station

Operators will enjoy the incredibly quiet and comfortable cab



A Safe, Quiet Cab

The Roll-Over Protective Structure (ROPS) cab provides you with a safe working environment. It also contributes to your comfort because it's attached to a reinforced frame with special viscous mounts that limit vibration and unnecessary sound. Add in special roof lining and sealing and you have a cab that's as quiet inside as today's top pickup trucks.

Comfortable Seat

The seat is an air suspension type with heat. It features a reclining back, upper and lower slide adjustments, and height and tilt angle adjustments to meet your needs for maximum comfort.

A Cool & Warm Environment

The automatic climate control system features multiple air outlets with filtered ventilation. Air flows on the floor, behind the seat, and in front of you to make your work in either hot or cold weather much more pleasant and productive.

Controls Just For You

The joystick consoles adjust to improve your comfort and productivity during the course of a day. The armrests telescope up and down just like a bicycle seat. Joysticks for tool control have buttons to make working with a two-way-flow grapple, thumb, and shear simple. The right joystick features a button that will reduce engine speed when you are not working to help save fuel. Touch it once and speed reduces; touch it again and speed increases for normal operation.

A Helpful Monitor

The LCD monitor is easy to see and navigate. Programmable in up to 44 languages to meet today's diverse workforce, the monitor clearly displays critical information you need to operate efficiently and effectively. Plus it projects the image from the standard rearview camera to help you see what's going on around you so you can stay safely focused on the job at hand.

Ample Storage & Auxiliary Power

Storage spaces are located in the front, rear, and side consoles of the cab. A drink holder accommodates a large mug, and a shelf behind the seat stores large lunch or toolboxes. Two 12-volt power supply sockets are conveniently located near the key storage areas for charging your electronic devices like an MP3 player, a cell phone, or a tablet.

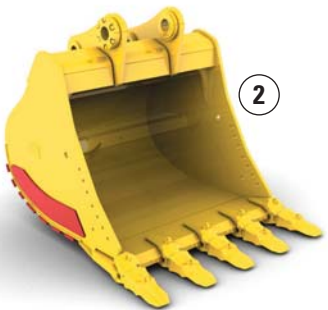
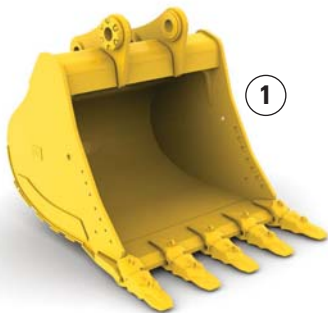

1) General Duty (GD) 2) Heavy Duty (HD)

Attachments

Tools to make you productive and profitable

Get The Most Out Of One Machine

You can easily expand the performance of your machine by utilizing any of the variety of attachments offered by Cat Work Tools.

Change Jobs Quickly

A quick coupler brings the ability to quickly change attachments and switch from job to job. The Cat Pin Grabber coupler is the secure way to decrease downtime and increase job site flexibility and overall productivity.

Dig, Finish & Compact

A wide range of buckets dig everything from top soil to harsh, abrasive material. For finishing and grading work, compact and shallow ditch cleaning buckets fit the need. A Cat compactor prepares the area for the next phase of construction.

Set Up Your Machine For Profitability

Your Cat dealer can install hydraulic kits to properly operate all Cat Work Tool attachments – maximizing the machine's uptime and your profits. All Cat Work Tool attachments are supported by the same Cat dealer network as your Cat machine



Integrated Technologies

Monitor, manage, and enhance job site operations



Cat Connect makes smart use of technology and services to improve your job site efficiency. Using the data from technology-equipped machines, you'll get more information and insight into your equipment and operations than ever before.

Cat Connect technologies offer improvements in these key areas:



EQUIPMENT
MANAGEMENT

Equipment Management – increase uptime and reduce operating costs.



PRODUCTIVITY

Productivity – monitor production and manage job site efficiency.



SAFETY

Safety – enhance job site awareness to keep your people and equipment safe.

LINK Technologies

LINK technologies, like Product Link™, are deeply integrated into your machine and wirelessly communicates key information, including location, hours, fuel usage, idle time and event codes.

Product Link/VisionLink®

Easy access to Product Link data via the online VisionLink user interface can help you see how your machine or fleet is performing. You can use this information to make timely, fact based decisions that can boost job site efficiency and productivity, and lower costs.



GRADE Technologies

Grade technologies combine digital design data and in-cab guidance to help you reach target grade quickly and accurately, with minimal staking and checking. That means you'll be more productive, complete jobs faster, in fewer passes, using less fuel, at a lower cost.



Cat Grade Control Depth and Slope

The factory integrated Cat Grade Control system delivers 2D bucket tip elevation guidance to the cab to help operators create precise planes and slopes with ease. Real-time bucket tip elevation guidance on the easy-to-read standard cab monitor indicates how much to cut or fill. Fast response sensors deliver immediate feedback, while optional integrated joystick buttons help operators make quick adjustments to maintain consistent, quality grades. Built-in alerts can be set to warn the operator if the linkage or bucket approaches a predefined elevation or depth, such as when working in areas with low ceilings, or digging near water lines. Staking and checking is minimized, which reduces ground crews and enhances job site safety.

Works best in simple 2D applications, such as digging basements or grading steep embankments. Easily upgrade to AccuGrade™ when 3D control is required.

Cat AccuGrade

The dealer-installed AccuGrade system provides 3D guidance for making complex cuts and contours, eliminating the need for staking and checking. A dedicated monitor displays a digital design plan with 3D bucket tip positioning and elevation guidance, indicating precisely where to work and how much to cut or fill.

Plug and play capability on the 315F L simplifies upgrading. Choose from satellite (GNSS) control for large projects with complex designs or total station (UTS) systems in areas with limited reception.





Front Linkage

Options to take on your far-reaching and up-close tasks

Link & Pins

The power link between the stick and bucket is designed for heavy-duty lifting over the long haul. With an integrated lifting eye, the power link helps enhance lifting capability by lowering your load point and maximizing the power built into the boom cylinders. All pins used in the front linkage have thick chrome plating to give them high wear and corrosion resistance. The large pins distribute load weight to ensure long pin, boom, and stick life.

Booms & Sticks

Two types of booms are available to meet a variety of tasks.

Reach Boom – The reach boom offers you excellent all-around versatility and a large working envelope, for any application such as digging dirt, moving rock, and doing the nearly endless amount of tasks you can do with Cat hydraulic work tools.

The 315F L is offered with a reach boom and two (2) stick configurations: R2.5 m and R3.0 m. The R3.0 m stick is best suited when you need deep trenching, longer reach, and top truck loading capabilities. The R2.5 m stick provides greater breakout force and increases productivity when you primarily plan on using hydromechanical work tools.

Variable Angle Boom (Europe only) – The variable angle boom offers superb flexibility and versatility in the working envelope. Boom position can be adjusted from 90° when fully retracted to 180° and fully extended.

The variable angle boom is offered with two (2) stick configurations: R2.1 m and R2.5 m.

Designed To Last

Each boom and stick is built with internal baffle plates for additional durability, and each undergoes ultrasound inspection to ensure quality and reliability. Large box-section structures with thick, multi-plate fabrications, castings, and forgings are used in high-stress areas such as the boom nose, boom foot, and boom and stick cylinders to enhance durability for the tough work you do. Your Cat dealer can help you pick the best combination for your business.

Structures & Undercarriage

You can take on a variety of tough tasks with this designed-to-last machine



The 315F L is a well-built machine designed to give you a very long service life. The upper frame has mountings made specifically to support the heavy-duty cab; it's also reinforced around key areas that take on stress like the boom foot and skirt. Massive bolts are used to attach the track frames to the body, and additional bolts are used throughout to increase the machine's digging force, which leads to more productivity for you.



Durable Undercarriage

The 315F L undercarriage contributes significantly to its outstanding stability and durability. Track shoes, links, rollers, idlers, and final drives are all built with long-lasting, high-tensile-strength steel. Cat Grease Lubricated Track 2 (GLT2) track link protects moving parts by keeping water, debris, and dust out and grease sealed in, which delivers longer wear life and reduced noise when traveling. Optional guide guards help maintain track alignment to improve the machine's overall performance – whether you're traveling on a flat, heavy bed of rock or a steep, wet field of mud.



Great Weight

The 315F L has a 3.56 mt counterweight. Rounded to minimize the amount of overhang, the counterweight is mounted directly to the main frame using massive bolts to ensure maximum rigidity. Plus it has an integrated housing to help protect the machine's standard rearview camera.

Serviceability

Designed to make your maintenance quick and easy

On-Board Monitoring

The 315F has a pre-start monitoring system that allows you to check coolant, hydraulic oil, and engine oil levels right inside the cab. The monitor also tells you fluid and filter change intervals to ensure you keep the machine in top-performing condition.

Safe, Convenient Access

You can see the service hour meter inside the cab and reach most routine maintenance items like fluid taps and grease points from the safety and convenience of ground level. Filters are banked together for higher service efficiency. Compartments feature wide service doors and heavy-duty hardware to keep them open – all to make service work simpler and more secure.

A Fresh Idea

The fresh air filter is conveniently located on the side of the cab to make it easy for you to reach and replace. It's protected by a lockable door that can only be opened with the engine key.

A Priming Solution

Located in the pump compartment, an electric fuel priming pump eliminates the need for you to manually prime after filter changes. It also eliminates the risk of fuel contamination by preventing unfiltered fuel from being backfilled during filter changes.

More Service Benefits

Drain tubes beneath the machine make it easy and simple for you to remove water and sediment during routine maintenance. They also make it easy to change oil without special tools or the risk of spilling. Same goes for an integrated fuel level indicator that pops up to help you reduce the possibility of fuel tank overfilling.

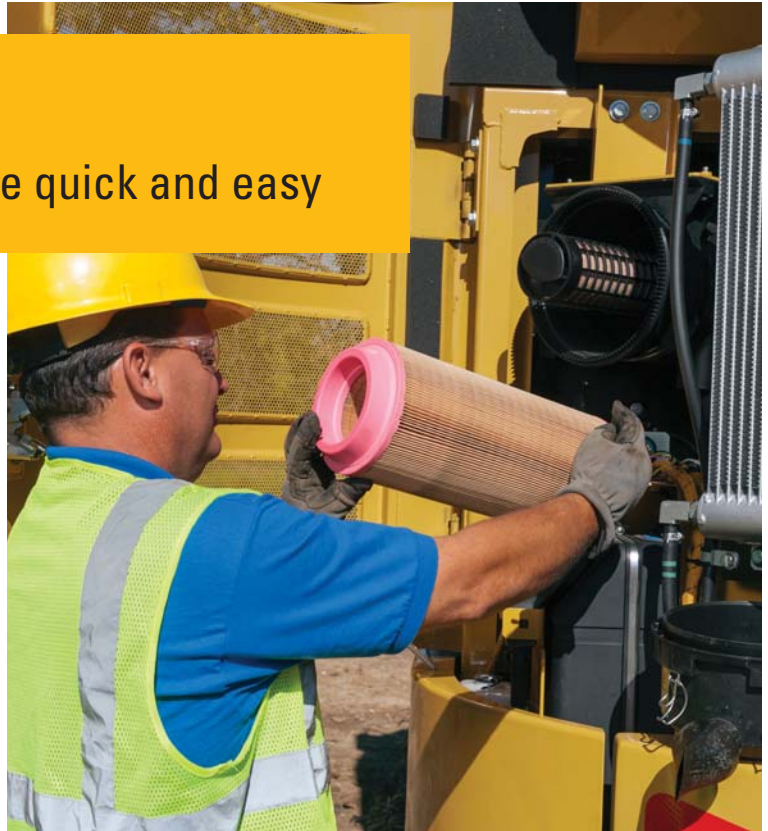

Safety

Features to help protect you day in and day out



A Safe, Quiet Cab

The roll-over protective structure (ROPS) cab provides you with a safe working environment when properly seated and belted. It also contributes to your comfort because it's attached to a reinforced frame with special viscous mounts that limit vibration and unnecessary sound, and it includes special roof lining and sealing to make it as quiet as any of today's top pickup trucks.

Secure Contact Points

Multiple large steps get you into the cab as well as a leg up to the compartments. Extended hand and guard rails allow you to safely climb to the upper deck and removable anti-skid plates. Anti-skid plates reduce your slipping hazards in all types of weather conditions.

Great Views

Ample glass gives you excellent visibility out front and to the side, and the standard rearview camera gives you a clear field of view behind the machine through the cab monitor. The available split-configuration windshield features an upper window with handles that make it easy to slide and store above you and a lower window that can be removed and stored on the inside wall of the cab. The large skylight serves as an emergency exit and provides you with enhanced visibility.

Smart Lighting

Halogen lights provide plenty of illumination, and the cab and boom lights can be programmed to stay on for up to 90 seconds after the engine's been turned off to help you safely exit the machine.

Guard Options

The 315F can be equipped with several guarding options. Following are just a few:

- Falling Object Guarding System (FOGS)
- Vandal guards
- Heavy-duty bottom guards
- Track guiding guards

Complete Customer Care

Support you can count on



Expert Advice You Can Trust

What are the job requirements and machine attachments? What production is needed? Your Cat dealer can provide recommendations to help you make the right machine choices.

Support Agreements To Fit Your Needs

Cat dealers offer a variety of customer support agreements and work with you to develop a plan to meet your specific needs. These plans can cover the entire machine, including attachments, to help protect your investment.

Parts When & Where You Need Them

Cat dealers utilize a worldwide parts network to maximize your machines' uptime. Plus they can help you save money with Cat remanufactured components.

Operating Techniques To Boost Your Profits

Improving operating techniques can boost your profits. Your Cat dealer has videos, literature, and other ideas to help you increase productivity. Caterpillar also offers simulators and certified operator training to help maximize the return on your investment.

Financial Options Just For You

Consider financing options and day-to-day operating costs. Look at dealer services that can be included in the machine's cost to yield lower owning and operating costs over time.

What's Best For You Today...& Tomorrow

Repair, rebuild, or replace? Your Cat dealer can help you evaluate the cost involved so you can make the best choice for your business.



Sustainability

Generations ahead in every way

- The C4.4 ACERT engine meets Tier 4 Final and Stage IV emission standards.
- The 315F L has the flexibility of running on either ultra-low-sulfur diesel (ULSD) fuel with 10 ppm of sulfur or less or biodiesel (up to B20) fuel blended with ULSD that meets ASTM 6751 standards.
- An overfill indicator rises when the fuel tank is full to help your service technicians avoid spilling.
- An unique engine oil filter eliminates the need for painted metal cans and aluminum top plates. The cartridge-style spin-on housing enables the internal filter to be separated and replaced; the used internal element can be incinerated to help reduce waste.
- The machine is built to be rebuilt with major structures and components capable of being remanufactured to reduce waste and replacement costs.
- The 315F L is an efficient, productive machine that reduces impact on natural resources for future generations.

315F L Hydraulic Excavator Specifications

Engine

Engine Model	Cat C4.4 ACERT
Gross Power – SAE J1995	74 kW (101 PS)
Engine Power – ISO 14396	74 kW (101 PS)
Net Power – ISO 9249/SAE J1349	72 kW (98 PS)
Bore	105 mm
Stroke	127 mm
Displacement	4.4 L

Weight

Minimum Operating Weight*	15 040 kg
Maximum Operating Weight**	17 300 kg

*4.65 m Reach boom with 2.5 m stick, 500 mm shoes and no blade.

**Variable Angle boom, 2.1 m stick, 700 mm shoes with blade.

Hydraulic System

Main System – Maximum Flow (Total)	256 L/min
Swing System – Maximum Flow	120 L/min
Maximum Pressure – Equipment	30 500 kPa
Maximum Pressure – Power Offset Boom (optional)	29 900 kPa
Maximum Pressure – Travel	35 000 kPa
Maximum Pressure – Swing	23 000 kPa
Pilot System – Maximum Flow	21.9 L/min
Pilot System – Maximum Pressure	4120 kPa
Boom Cylinder – Bore	110 mm
Boom Cylinder – Stroke	1000 mm
Stick Cylinder – Bore	120 mm
Stick Cylinder – Stroke	1197 mm
Bucket Cylinder – Bore	100 mm
Bucket Cylinder – Stroke	939 mm

Drive

Gradeability	30°/70%
Maximum Travel Speed	5.5 km/h
Maximum Drawbar Pull	112 kN

Swing Mechanism

Swing Speed	11 rpm
Swing Torque	30.9 kN·m

Service Refill Capacities

Fuel Tank Capacity	178 L
DEF Tank Capacity	19 L
Cooling System	28 L
Engine Oil (with filter)	13.5 L
Swing Drive (each)	3 L
Final Drive (each)	3 L
Hydraulic System (including tank)	160 L
Hydraulic Tank	84 L

Track

Long Undercarriage	
Number of Shoes (each side)	46 pieces
Number of Track Rollers (each side)	7 pieces
Number of Carrier Rollers (each side)	2 pieces

Sound Performance

Operator Sound Pressure Level (ISO 6396:2008)	69 dB(A)
Exterior Sound Power Level (ISO 6395:2008)*	101 dB(A)

* European Union Directive “2000/14/EC” as amended by “2005/88/EC.”

- Hearing protection may be needed when operating with an open operator station and cab (when not properly maintained or doors/windows open) for extended periods or in noisy environment.

Standards

Brakes	ISO 10265 2008
ROPS Cab	ISO 12117-2
Cab/OPG	ISO 10262 1998

315F L Hydraulic Excavator Specifications

Dimensions

All dimensions are approximate.

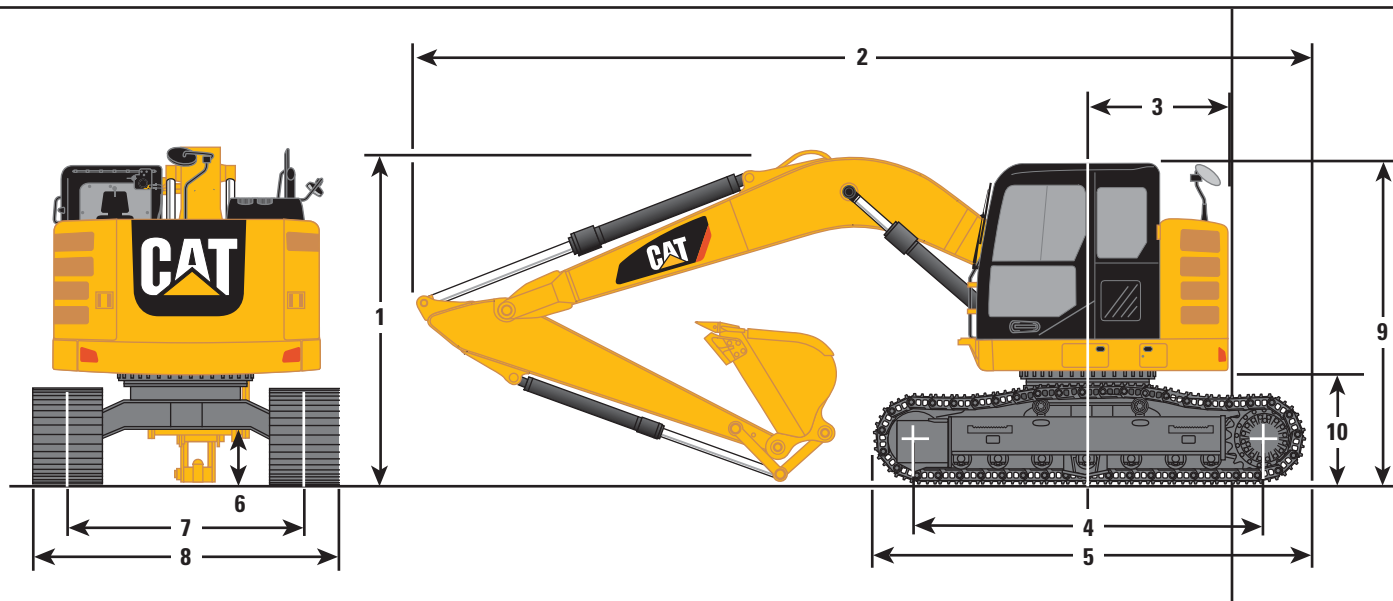

Boom Type	Reach Boom – 4.65 m		Variable Angle Boom*	
Stick Size	R3.0 m	R2.5 m	R2.5 m	R2.1 m
Bucket Type	GD	GD	GD	GD
Bucket Capacity	0.53 m ³	0.53 m ³	0.53 m ³	0.53 m ³
Tip Radius	1225 mm	1225 mm	1225 mm	1225 mm
1 Shipping Height	3000 mm	3000 mm	3000 mm	3000 mm
2 Shipping Length				
Long Undercarriage with Blade	8010 mm	8010 mm	8080 mm	8010 mm
3 Tail Swing Radius	1530 mm	1530 mm	1530 mm	1530 mm
4 Length to Center of Rollers	3040 mm	3040 mm	3040 mm	3040 mm
5 Track Length	3750 mm	3750 mm	3750 mm	3750 mm
6 Ground Clearance	440 mm	440 mm	440 mm	440 mm
7 Track Gauge (Shipping)	1990 mm	1990 mm	1990 mm	1990 mm
8 Transport Width – Long Undercarriage				
500 mm Shoes	2490 mm	2490 mm	2490 mm	2490 mm
600 mm Shoes	2590 mm	2590 mm	2590 mm	2590 mm
700 mm Shoes	2690 mm	2690 mm	2690 mm	2690 mm
9 Cab Height	2810 mm	2810 mm	2810 mm	2810 mm
Cab Height with Top Guard	2950 mm	2950 mm	2950 mm	2950 mm
10 Counterweight Clearance	860 mm	860 mm	860 mm	860 mm

*Europe only.

315F L Hydraulic Excavator Specifications

Working Ranges

All dimensions are approximate.

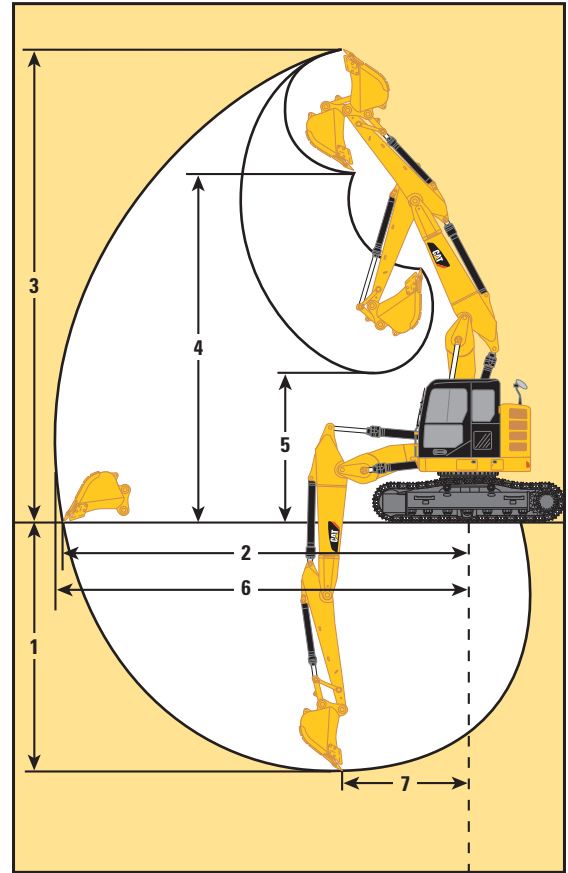
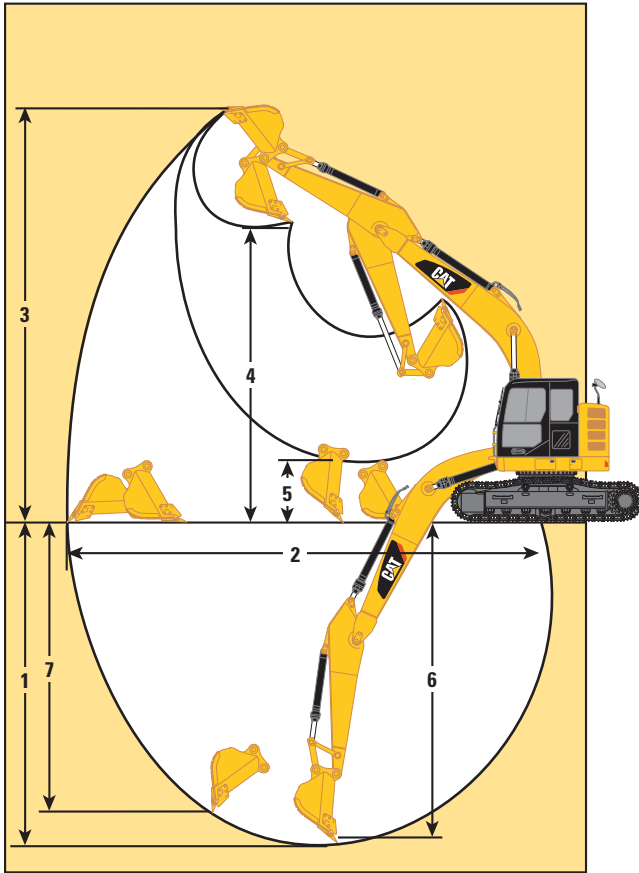

Boom Type	Reach Boom – 4.65 m		Variable Angle Boom*	
	R3.0 m	R2.5 m	R2.5 m	R2.1 m
Stick Size	0.53 m ²	0.53 m ²	0.53 m ²	0.53 m ²
Bucket	1225 mm	1225 mm	1225 mm	1225 mm
Tip Radius	5950 mm	5450 mm	5140 mm	4740 mm
1 Maximum Digging Depth	8680 mm	8230 mm	8360 mm	7980 mm
2 Maximum Reach at Ground Level	9640 mm	9310 mm	9410 mm	9090 mm
3 Maximum Cutting Height	7190 mm	6860 mm	6960 mm	6640 mm
4 Maximum Loading Height	2060 mm	2500 mm	2590 mm	2970 mm
5 Minimum Loading Height	5770 mm	5240 mm	5020 mm	4610 mm
6 Maximum Depth Cut for 2440 mm Level Bottom	5280 mm	4880 mm	4200 mm	3780 mm
7 Maximum Vertical Wall Digging Depth				

*Europe only.

315F L Hydraulic Excavator Specifications

Operating Weight and Ground Pressures

	700 mm Triple Grouser Shoes		600 mm Triple Grouser Shoes		500 mm Triple Grouser Shoes	
Long Undercarriage without Blade – 3.56 mt Counterweight						
Reach Boom – 4.65 m						
R3.0 m	15 640 kg	33.3 kPa	15 370 kg	38.2 kPa	15 120 kg	45.1 kPa
R2.5 m	15 560 kg	33.1 kPa	15 290 kg	38.0 kPa	15 040 kg	44.9 kPa
Long Undercarriage with Blade – 3.56 mt Counterweight						
Reach Boom – 4.65 m						
R3.0 m	16 480 kg	35.1 kPa	16 200 kg	40.3 kPa	15 950 kg	47.6 kPa
R2.5 m	16 400 kg	34.9 kPa	16 120 kg	40.1 kPa	15 860 kg	47.3 kPa
Variable Angle Boom						
R2.5 m	17 300 kg	36.8 kPa	17 000 kg	42.2 kPa	16 800 kg	50.1 kPa
R2.1 m	17 300 kg	36.8 kPa	17 000 kg	42.2 kPa	16 800 kg	50.1 kPa

315F L Hydraulic Excavator Specifications

Major Component Weights

	kg
Base Machine with Boom Cylinder without Counterweight, Front Linkage and Track	5100
Long Undercarriage	2650
Counterweight	3560
Boom (includes lines, pins and stick cylinder)	
Reach Boom – 4.65 m	1023
Variable Angle Boom	1740
Stick (includes lines, pins, bucket cylinder and bucket linkage)	
R3.0 m	667
R2.5 m	588
R2.1 m	590
Track Shoe (Long/per two tracks)	
500 mm Triple Grouser	1567
600 mm Triple Grouser	1815
700 mm Triple Grouser	2085
CW Dedicated Quick Coupler	205
Blade	
2500 mm	830
2600 mm	830
2700 mm	840
Bucket with Sidecutter and Tip	
GD 0.53 m ³	440

All weights are rounded up to nearest 10 kg and lb.

Base machine includes 75 kg operator weight, 90% fuel weight, and undercarriage with center guard.

Bucket and Stick Forces

Boom Type	Reach Boom – 4.65 m		Variable Angle Boom		
	Stick Size	R3.0 m	R2.5 m	R2.5 m	R2.1 m
Bucket Digging Force (SAE)		85.2 kN	85 kN	85 kN	85 kN
Bucket Digging Force (ISO)		95.3 kN	95 kN	95 kN	95.1 kN
Stick Digging Force (SAE)		57 kN	63.6 kN	63.6 kN	71.4 kN
Stick Digging Force (ISO)		58.4 kN	65.3 kN	65.3 kN	73.6 kN

Caterpillar recommends using appropriate work tools to maximize the value customers receive from our products. Use of work tools, including buckets, which are outside of Caterpillar's recommendations or specifications for weight, dimensions, flows, pressures, etc. may result in less-than-optimal performance, including but not limited to reductions in production, stability, reliability, and component durability. Improper use of a work tool resulting in sweeping, prying, twisting and/or catching of heavy loads will reduce the life of the boom and stick.

315F L Hydraulic Excavator Specifications

Reach Boom Lift Capacities – Counterweight: 3.56 mt – Blade Up

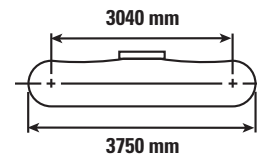
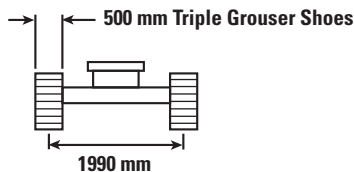
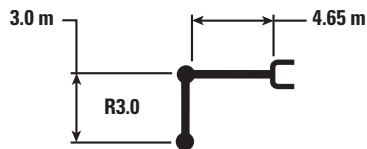

Reach (m)	Unit	1.5 m		3.0 m		4.5 m		6.0 m		7.5 m		m		
		Hydraulic	Tipping	Hydraulic	Tipping	Hydraulic	Tipping	Hydraulic	Tipping	Hydraulic	Tipping	Hydraulic	Tipping	
7.5 m	kg					*2600	*2600					*2500	*2500	4.54
6.0 m	kg					*3400	*3400	*2300	*2300			*2100	*2100	6.08
4.5 m	kg					*3650	*3650	*3350	2750			*1950	*1950	6.96
3.0 m	kg			*5900	*5900	*4300	4100	*3600	2650			*1950	1850	7.44
1.5 m	kg			*7950	6850	*5050	3800	3850	2500	*2450	1800	*2050	1750	7.59
0.0 m	kg			*7350	6350	*5500	3550	3700	2400			*2300	1800	7.43
-1.5 m	kg	*4500	*4500	*7900	6250	*5300	3450	3650	2350			*2700	1950	6.94
-3.0 m	kg	*7550	*7550	*6300	*6300	*4400	3450	*2850	2350			*2800	2350	6.05
-4.5 m	kg			*3400	*3400							*2050	*2050	4.49



ISO 10567



*Indicates that the load is limited by hydraulic lifting capacity rather than tipping load. The above loads are in compliance with hydraulic excavator lift capacity standard ISO 10567:2007. They do not exceed 87% of hydraulic lifting capacity or 75% of tipping load. Weight of all lifting accessories must be deducted from the above lifting capacities. Lifting capacities are based on the machine standing on a firm, uniform supporting surface. The use of a work tool attachment point to handle/lift objects, could affect the machine lift performance.

Lift capacity stays with $\pm 5\%$ for all available track shoes.

Always refer to the appropriate Operation and Maintenance Manual for specific product information.

315F L Hydraulic Excavator Specifications

Reach Boom Lift Capacities – Counterweight: 3.56 mt – Blade Up

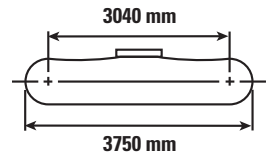
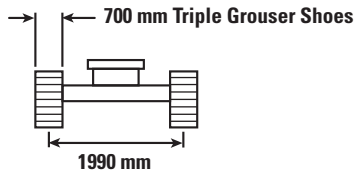
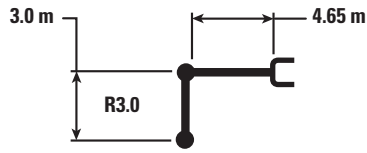

Reach (m)	Unit	1.5 m		3.0 m		4.5 m		6.0 m		7.5 m		m		
		ISO 10567	ISO 10567	ISO 10567	ISO 10567	ISO 10567	ISO 10567	ISO 10567	ISO 10567	ISO 10567	ISO 10567	ISO 10567	ISO 10567	
7.5 m	kg					*2600	*2600					*2500	*2500	4.54
6.0 m	kg					*3400	*3400	*2300	*2300			*2100	*2100	6.08
4.5 m	kg					*3650	*3650	*3350	2800			*1950	*1950	6.96
3.0 m	kg			*5900	*5900	*4300	4200	*3600	2750			*1950	1950	7.44
1.5 m	kg			*7950	7100	*5050	3900	*3900	2600	*2450	1850	*2050	1850	7.59
0.0 m	kg			*7350	6600	*5500	3700	3850	2500			*2300	1850	7.43
-1.5 m	kg	*4500	*4500	*7900	6450	*5300	3550	3750	2400			*2700	2000	6.94
-3.0 m	kg	*7550	*7550	*6300	*6300	*4400	3550	*2850	2450			*2800	2450	6.05
-4.5 m	kg			*3400	*3400							*2050	*2050	4.49



ISO 10567



*Indicates that the load is limited by hydraulic lifting capacity rather than tipping load. The above loads are in compliance with hydraulic excavator lift capacity standard ISO 10567:2007. They do not exceed 87% of hydraulic lifting capacity or 75% of tipping load. Weight of all lifting accessories must be deducted from the above lifting capacities. Lifting capacities are based on the machine standing on a firm, uniform supporting surface. The use of a work tool attachment point to handle/lift objects, could affect the machine lift performance.

Lift capacity stays with $\pm 5\%$ for all available track shoes.

Always refer to the appropriate Operation and Maintenance Manual for specific product information.

315F L Hydraulic Excavator Specifications

Reach Boom Lift Capacities – Counterweight: 3.56 mt – Blade Up

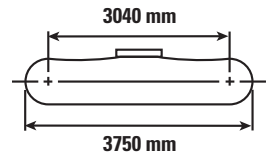
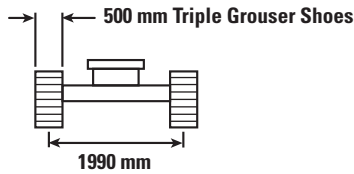
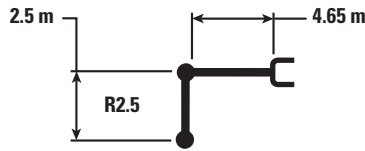

Reach (m)	Unit	1.5 m		3.0 m		4.5 m		6.0 m		315F L Hydraulic Excavator		m
		Hydraulic	Tipping	Hydraulic	Tipping	Hydraulic	Tipping	Hydraulic	Tipping	Hydraulic	Tipping	
7.5 m	kg			*4400	*4400					*3050	*3050	3.74
6.0 m	kg					*3850	*3850			*2400	*2400	5.51
4.5 m	kg			*4550	*4550	*4050	*4050	*3650	2700	*2250	*2250	6.47
3.0 m	kg			*6700	*6700	*4700	4050	*3800	2650	*2200	2050	6.99
1.5 m	kg			*7250	6700	*5350	3750	3850	2500	*2350	1950	7.15
0.0 m	kg			*6500	6400	*5550	3550	3750	2400	*2600	2000	6.98
-1.5 m	kg	*4950	*4950	*7450	6350	*5150	3500	*3650	2400	*3100	2200	6.46
-3.0 m	kg	*7300	*7300	*5550	*5550	*3950	3550			*2800	2750	5.48



ISO 10567



*Indicates that the load is limited by hydraulic lifting capacity rather than tipping load. The above loads are in compliance with hydraulic excavator lift capacity standard ISO 10567:2007. They do not exceed 87% of hydraulic lifting capacity or 75% of tipping load. Weight of all lifting accessories must be deducted from the above lifting capacities. Lifting capacities are based on the machine standing on a firm, uniform supporting surface. The use of a work tool attachment point to handle/lift objects, could affect the machine lift performance.

Lift capacity stays with $\pm 5\%$ for all available track shoes.

Always refer to the appropriate Operation and Maintenance Manual for specific product information.

315F L Hydraulic Excavator Specifications

Reach Boom Lift Capacities – Counterweight: 3.56 mt – Blade Up

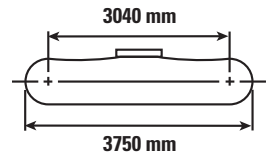
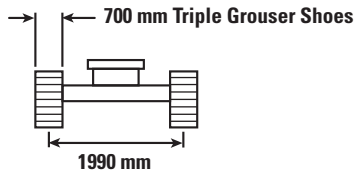
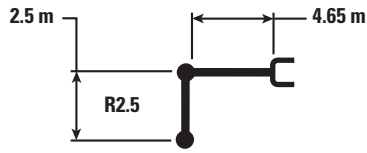

Reach (m)	Unit	1.5 m		3.0 m		4.5 m		6.0 m				m
		Hydraulic	Tipping	Hydraulic	Tipping	Hydraulic	Tipping	Hydraulic	Tipping	Hydraulic	Tipping	
7.5 m	kg			*4400	*4400					*3050	*3050	3.74
6.0 m	kg					*3850	*3850			*2400	*2400	5.51
4.5 m	kg			*4550	*4550	*4050	*4050	*3650	2800	*2250	*2250	6.47
3.0 m	kg			*6700	*6700	*4700	4150	*3800	2700	*2200	2150	6.99
1.5 m	kg			*7250	6950	*5350	3900	3950	2600	*2350	2000	7.15
0.0 m	kg			*6500	*6500	*5550	3700	3850	2500	*2600	2050	6.98
-1.5 m	kg	*4950	*4950	*7450	6600	*5150	3600	*3650	2450	*3100	2250	6.46
-3.0 m	kg	*7300	*7300	*5550	*5550	*3950	3650			*2800	*2800	5.48



ISO 10567



*Indicates that the load is limited by hydraulic lifting capacity rather than tipping load. The above loads are in compliance with hydraulic excavator lift capacity standard ISO 10567:2007. They do not exceed 87% of hydraulic lifting capacity or 75% of tipping load. Weight of all lifting accessories must be deducted from the above lifting capacities. Lifting capacities are based on the machine standing on a firm, uniform supporting surface. The use of a work tool attachment point to handle/lift objects, could affect the machine lift performance.

Lift capacity stays with $\pm 5\%$ for all available track shoes.

Always refer to the appropriate Operation and Maintenance Manual for specific product information.

315F L Hydraulic Excavator Specifications

Variable Angle Boom Lift Capacities – Counterweight: 3.56 mt – Blade Up

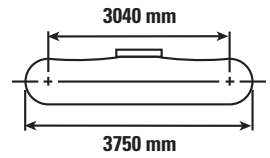
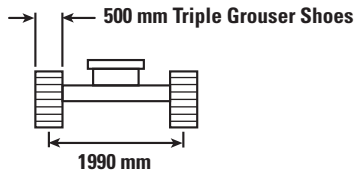
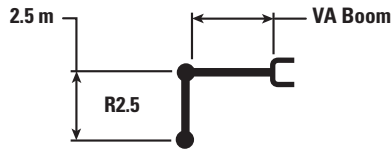

Reach (m)	Unit	1.5 m		3.0 m		4.5 m		6.0 m		Diagram		m
		Hydraulic	Tipping	Hydraulic	Tipping	Hydraulic	Tipping	Hydraulic	Tipping	Hydraulic	Tipping	
7.5	kg									*2700	*2700	3.99
6.0	kg					*3000	*3000			*2150	*2150	5.68
4.5	kg			*4600	*4600	*4250	4250	*2050	*2050	*2000	*2000	6.62
3.0	kg			*6650	*6650	*4050	3950	*2100	*2100	*1950	1950	7.12
1.5	kg	*4000	*4000	*6300	*6300	*4350	3650	*2300	*2300	*2050	1850	7.27
0.0	kg	*3900	*3900	*5900	*5900	*5100	3450	*2800	2350	*2250	1850	7.11
-1.5	kg	*6100	*6100	*4750	*4750	*3900	3350	*2600	2300	*1850	*1850	6.60
-3.0	kg	*7450	*7450	*3150	*3150	*2050	*2050			*1650	*1650	5.35



ISO 10567



*Indicates that the load is limited by hydraulic lifting capacity rather than tipping load. The above loads are in compliance with hydraulic excavator lift capacity standard ISO 10567:2007. They do not exceed 87% of hydraulic lifting capacity or 75% of tipping load. Weight of all lifting accessories must be deducted from the above lifting capacities. Lifting capacities are based on the machine standing on a firm, uniform supporting surface. The use of a work tool attachment point to handle/lift objects, could affect the machine lift performance.

VA cylinder is flexible.

Lift capacity stays with $\pm 5\%$ for all available track shoes.

Always refer to the appropriate Operation and Maintenance Manual for specific product information.

315F L Hydraulic Excavator Specifications

Variable Angle Boom Lift Capacities – Counterweight: 3.56 mt – Blade Up

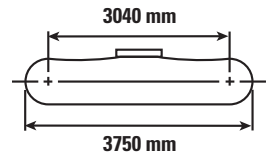
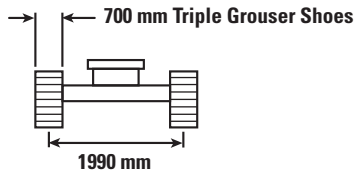
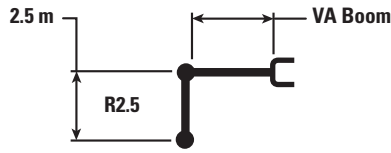

Reach (m)	Unit	1.5 m		3.0 m		4.5 m		6.0 m				m
		Hydraulic	Tipping	Hydraulic	Tipping	Hydraulic	Tipping	Hydraulic	Tipping	Hydraulic	Tipping	
7.5	kg									*2700	*2700	3.99
6.0	kg					*3000	*3000			*2150	*2150	5.68
4.5	kg			*4600	*4600	*4250	*4250	*2050	*2050	*2000	*2000	6.62
3.0	kg			*6650	*6650	*4050	*4050	*2100	*2100	*1950	*1950	7.12
1.5	kg	*4000	*4000	*6300	*6300	*4350	3800	*2300	*2300	*2050	1900	7.27
0.0	kg	*3900	*3900	*5900	*5900	*5100	3550	*2800	2400	*2250	1900	7.11
-1.5	kg	*6100	*6100	*4750	*4750	*3900	3500	*2600	2400	*1850	*1850	6.60
-3.0	kg	*7450	*7450	*3150	*3150	*2050	*2050			*1650	*1650	5.35



ISO 10567



*Indicates that the load is limited by hydraulic lifting capacity rather than tipping load. The above loads are in compliance with hydraulic excavator lift capacity standard ISO 10567:2007. They do not exceed 87% of hydraulic lifting capacity or 75% of tipping load. Weight of all lifting accessories must be deducted from the above lifting capacities. Lifting capacities are based on the machine standing on a firm, uniform supporting surface. The use of a work tool attachment point to handle/lift objects, could affect the machine lift performance.

VA cylinder is flexible.

Lift capacity stays with $\pm 5\%$ for all available track shoes.

Always refer to the appropriate Operation and Maintenance Manual for specific product information.

315F L Hydraulic Excavator Specifications

Variable Angle Boom Lift Capacities – Counterweight: 3.56 mt – Blade Up

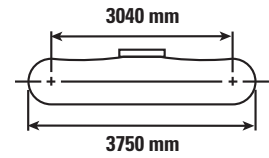
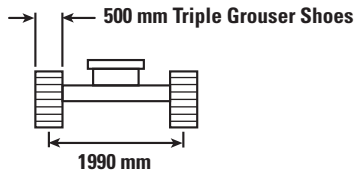
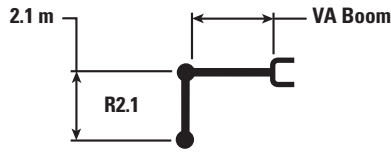

Reach (m)	Unit	1.5 m		3.0 m		4.5 m		6.0 m				m
		Hydraulic	Tipping	Hydraulic	Tipping	Hydraulic	Tipping	Hydraulic	Tipping	Hydraulic	Tipping	
7.5	kg			*3600	*3600					*3600	*3600	3.22
6.0	kg					*2800	*2800			*2700	*2700	5.18
4.5	kg			*6100	*6100	*4000	*4000	*2550	*2550	*2450	*2450	6.19
3.0	kg			*6600	*6600	*3900	3850	*2700	2500	*2400	2100	6.73
1.5	kg			*6350	*6350	*4650	3550	*2850	2400	*2500	1950	6.89
0.0	kg	*5250	*5250	*5300	*5300	*4850	3400	*3400	2300	*2550	2000	6.72
-1.5	kg	*7500	*7500	*3750	*3750	*3400	3350	*2100	*2100	*1800	*1800	6.18
-3.0	kg	*7500	*7500	*3200	*3200	*2000	*2000			*2000	*2000	4.59



ISO 10567



*Indicates that the load is limited by hydraulic lifting capacity rather than tipping load. The above loads are in compliance with hydraulic excavator lift capacity standard ISO 10567:2007. They do not exceed 87% of hydraulic lifting capacity or 75% of tipping load. Weight of all lifting accessories must be deducted from the above lifting capacities. Lifting capacities are based on the machine standing on a firm, uniform supporting surface. The use of a work tool attachment point to handle/lift objects, could affect the machine lift performance.

VA cylinder is flexible.

Lift capacity stays with $\pm 5\%$ for all available track shoes.

Always refer to the appropriate Operation and Maintenance Manual for specific product information.

315F L Hydraulic Excavator Specifications

Variable Angle Boom Lift Capacities – Counterweight: 3.56 mt – Blade Up

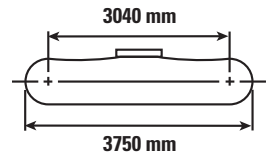
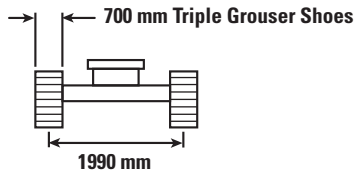
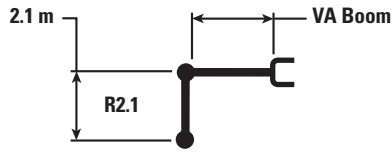

Reach (m)	Unit	1.5 m		3.0 m		4.5 m		6.0 m		315F L Hydraulic Excavator		m
		Hydraulic	Tipping	Hydraulic	Tipping	Hydraulic	Tipping	Hydraulic	Tipping	Hydraulic	Tipping	
7.5	kg			*3600	*3600					*3600	*3600	3.22
6.0	kg					*2800	*2800			*2700	*2700	5.18
4.5	kg			*6100	*6100	*4000	*4000	*2550	*2550	*2450	*2450	6.19
3.0	kg			*6600	*6600	*3900	*3900	*2700	2600	*2400	2150	6.73
1.5	kg			*6350	*6350	*4650	3700	*2850	2500	*2500	2050	6.89
0.0	kg	*5250	*5250	*5300	*5300	*4850	3500	*3400	2400	*2550	2050	6.72
-1.5	kg	*7500	*7500	*3750	*3750	*3400	*3400	*2100	*2100	*1800	*1800	6.18
-3.0	kg	*7500	*7500	*3200	*3200	*2000	*2000			*2000	*2000	4.59



ISO 10567



*Indicates that the load is limited by hydraulic lifting capacity rather than tipping load. The above loads are in compliance with hydraulic excavator lift capacity standard ISO 10567:2007. They do not exceed 87% of hydraulic lifting capacity or 75% of tipping load. Weight of all lifting accessories must be deducted from the above lifting capacities. Lifting capacities are based on the machine standing on a firm, uniform supporting surface. The use of a work tool attachment point to handle/lift objects, could affect the machine lift performance.

VA cylinder is flexible.

Lift capacity stays with ±5% for all available track shoes.

Always refer to the appropriate Operation and Maintenance Manual for specific product information.

315F L Hydraulic Excavator Specifications

Work Tool Offering Guide*

Boom Type	Reach Boom		Variable Angle Boom	
Stick Size	R3.0 m	R2.5 m	R2.5 m	R2.1 m
Hydraulic Hammer	H110Es H115Es	H110Es H115Es	H110Es	H110Es
Demolition and Sorting Grapple	G310B	G310B		
Mobile Scrap and Demolition Shear	S320B	S320B		
Compactor (Vibratory Plate)	CVP75	CVP75	CVP75	CVP75
Contractors' Grapple	G112B	G112B	G112B	G112B
Orange Peel Grapple				
Trash Grapple				
Thumbs				
Rakes				
Center-Lock™ Pin Grabber Coupler				
Dedicated Quick Coupler				

These work tools are available for the 315F L.
Consult your Cat dealer for proper match.

*Matches are dependent on excavator configurations. Consult your Cat dealer to determine what is offered in your area and for proper work tool match.
Based on 3.56 mt counterweight.

315F L Hydraulic Excavator Specifications

Bucket Specifications and Compatibility

	Width	Capacity	Weight	Fill	Reach Boom		VA Boom	
	mm	m ³	kg	%	R3.0 m	R2.5 m	R2.5 m	R2.1 m
Without Quick Coupler								
General Duty (GD)	600	0.31	315	100%	●	●	●	●
	750	0.41	362	100%	●	●	●	●
	900	0.53	411	100%	●	●	●	●
	1000	0.60	436	100%	⊙	●	●	●
	1100	0.68	470	100%	⊖	⊙	●	●
	1200	0.76	499	100%	X	X	⊙	⊙
Heavy Duty (HD)	450	0.20	276	100%	●	●	●	●
	1200	0.76	506	100%	○	⊖	⊙	⊙
Maximum load pin-on (payload + bucket)				kg	1570	1780	1845	1985
With Pin Grabber Quick Coupler								
General Duty (GD)	600	0.31	315	100%	●	●	●	●
	750	0.41	362	100%	●	●	●	●
	900	0.53	411	100%	⊙	●	●	●
	1000	0.60	436	100%	⊖	⊙	⊙	●
	1100	0.68	470	100%	○	⊖	⊖	⊙
	1200	0.76	499	100%	◇	○	⊖	⊖
Heavy Duty (HD)	450	0.20	276	100%	●	●	●	●
	1200	0.76	506	100%	◇	○	⊖	⊖
Maximum load with coupler (payload + bucket)				kg	1324	1534	1599	1739

The above loads are in compliance with hydraulic excavator standard EN474, they do not exceed 87% of hydraulic lifting capacity or 75% of tipping capacity with front linkage fully extended at ground line with bucket curled.

Capacity based on ISO 7451.

Bucket weight with Long tips.

Maximum Material Density:

- 2100 kg/m³
- ⊙ 1800 kg/m³
- ⊖ 1500 kg/m³
- 1200 kg/m³
- ◇ 900 kg/m³
- X Not Recommended

Caterpillar recommends using appropriate work tools to maximize the value customers receive from our products. Use of work tools, including buckets, which are outside of Caterpillar's recommendations or specifications for weight, dimensions, flows, pressures, etc. may result in less-than-optimal performance, including but not limited to reductions in production, stability, reliability, and component durability. Improper use of a work tool resulting in sweeping, prying, twisting and/or catching of heavy loads will reduce the life of the boom and stick.

315F L Hydraulic Excavator Specifications

Bucket Specifications and Compatibility

	Width	Capacity	Weight	Fill	Reach Boom			VA Boom	
	mm	m ³	kg	%	R3.0 m	R2.5 m	R2.1 m	R2.5 m	R2.1 m
With CW Dedicated Quick Coupler (CW20/CW20s)									
General Duty (GD)	450	0.20	300	100%	●	●	●	●	●
	500	0.24	309	100%	●	●	●	●	●
	600	0.31	328	100%	●	●	●	●	●
	750	0.41	374	100%	●	●	●	●	●
	900	0.53	423	100%	⊙	●	●	●	●
	1000	0.60	452	100%	⊖	⊙	●	⊙	●
	1100	0.68	482	100%	○	⊖	⊙	⊖	⊙
	1200	0.76	511	100%	◇	○	⊖	⊖	⊖
Heavy Duty (HD)	500	0.24	319	100%	●	●	●	●	●
	1200	0.76	511	100%	◇	○	⊖	⊖	⊖
Maximum load with coupler (payload + bucket)				kg	1359	1569	1709	1634	1774

The above loads are in compliance with hydraulic excavator standard EN474, they do not exceed 87% of hydraulic lifting capacity or 75% of tipping capacity with front linkage fully extended at ground line with bucket curled.

Capacity based on ISO 7451.

Bucket weight with Long tips.

Maximum Material Density:

- 2100 kg/m³
- ⊙ 1800 kg/m³
- ⊖ 1500 kg/m³
- 1200 kg/m³
- ◇ 900 kg/m³

Caterpillar recommends using appropriate work tools to maximize the value customers receive from our products. Use of work tools, including buckets, which are outside of Caterpillar's recommendations or specifications for weight, dimensions, flows, pressures, etc. may result in less-than-optimal performance, including but not limited to reductions in production, stability, reliability, and component durability. Improper use of a work tool resulting in sweeping, prying, twisting and/or catching of heavy loads will reduce the life of the boom and stick.

315F L Standard Equipment

Standard Equipment

Standard equipment may vary. Consult your Cat dealer for details.

ENGINE

- C4.4 ACERT diesel engine
- Biodiesel capable
- Meets Tier 4 Final and Stage IV emission standards
- 2300 m altitude capability
- Electric priming pump
- Automatic engine speed control
- Economy and high power modes
- Two-speed travel
- Side-by-side cooling system
- Radial seal air filter
- Primary filter with water separator and water separator indicator
- Secondary filter
- Screen filter in fuel line
- Variable speed fan with viscous clutch
- Air prefilter

CAB

- Seat, high-back air suspension with heater
- Pressurized operator station with positive filtration
- Sliding upper door window (left-hand cab door)
- Removable lower windshield with in cab storage bracket
- Radial wiper and washer
- Coat hook
- Beverage holder
- Literature holder
- Seatbelt, 51 mm
- Two stereo speakers
- Storage shelf suitable for lunch or toolbox
- Color LCD display with indicators, filter/fluid change, and working hour information
- Adjustable armrest
- Height adjustable joystick consoles
- Neutral lever (lock out) for all controls
- Travel control pedals with removable hand levers
- Capability of installing additional pedal
- Power outlets, 5 amp
- Laminated glass front upper window and tempered other windows
- Rain protector

ELECTRICAL

- 80 amp alternator
- Circuit breaker
- Capability to electrically connect a beacon

HYDRAULIC SYSTEM

- Boom drift reduction valve
- Regeneration circuit for boom and stick
- Reverse swing dampening valve
- Automatic swing parking brake
- High-performance hydraulic return filter

COUNTERWEIGHT

- 3.56 mt

LIGHTS

- Working lights, cab and boom mounted, with time delay function
- Exterior light on storage box

UNDERCARRIAGE

- Center track guiding guard
- Grease Lubricated Track GLT2, resin seal
- Towing eye on base frame
- Swivel guard
- Bottom guard
- Travel motor guard

SECURITY

- Cat one key security system
- Door locks
- Cap locks on fuel and hydraulic tanks
- Lockable external tool/storage box
- Signaling/warning horn
- Secondary engine shutoff switch
- Rear window for emergency exit
- Guard, travel motor protection
- Guard rail
- Rearview camera

TECHNOLOGY

- Product Link

Optional Equipment

Optional equipment may vary. Consult your Cat dealer for details.

CAB

- Right pedal
- Rain protector
- AM/FM radio
- Radio with MP3 auxiliary audio port
- Travel alarm

ELECTRICAL

- Electric refueling pump

FRONT LINKAGE

- Reach boom, 4.65 m [with Boom Lowering Control Valve (BLCV), Stick Lowering Control Valve (SLCV)]
 - 2.5 m stick (with/without Grade Control)
 - 3.0 m stick
- Variable Angle boom (with BLCV, SLCV)
 - 2.1 m stick (with/without Grade Control)
 - 2.5 m stick
- Power Offset boom (with BLCV, SLCV)
 - 2.13 m stick
- Bucket linkage (with lifting eye)
- CW dedicated and Pin Grabber quick couplers

HYDRAULIC SYSTEM

- Control pattern quick-changer, two way
- Auxiliary hydraulics
- Boom and stick high pressure lines
- Boom and stick medium pressure lines
- Boom, stick and bucket QC lines
- Cat Bio hydraulic oil

UNDERCARRIAGE

- 500 mm triple grouser shoes
- 600 mm triple grouser shoes
- 700 mm triple grouser shoes
- Rubber pad for 500 mm triple grouser shoes
- 2500 mm blade with replaceable cutting edge
- 2600 mm blade with replaceable cutting edge
- 2700 mm blade with replaceable cutting edge

SECURITY

- Falling Object Guard (FOGS), bolt-on
- Guard, vandalism
- Security system fitted (MSS)
- Right sideview camera

TECHNOLOGY

- Cat Grade Control Depth and Slope

For more complete information on Cat products, dealer services, and industry solutions, visit us on the web at www.cat.com

AEHQ7807 (04-2016)
(EU)

© 2016 Caterpillar
All rights reserved

Materials and specifications are subject to change without notice. Featured machines in photos may include additional equipment. See your Cat dealer for available options.

CAT, CATERPILLAR, SAFETY.CAT.COM, their respective logos, "Caterpillar Yellow" and the "Power Edge" trade dress, as well as corporate and product identity used herein, are trademarks of Caterpillar and may not be used without permission.

VisionLink is a trademark of Trimble Navigation Limited, registered in the United States and in other countries.

